

12-Bit DACs with Internal V_{REF} and SPI™ Interface

Features

- 12-Bit Resolution
- ± 0.2 LSb DNL (typ.)
- ± 2 LSb INL (typ.)
- Single or Dual Channel
- Rail-to-Rail Output
- SPI™ Interface with 20 MHz Clock Support
- Simultaneous Latching of the Dual DACs with \overline{LDAC} pin
- Fast Settling Time of 4.5 μ s
- Selectable Unity or 2x Gain Output
- 2.048V Internal Band Gap Voltage Reference
- 50 ppm/°C V_{REF} Temperature Coefficient
- 2.7V to 5.5V Single-Supply Operation
- Extended Temperature Range: -40°C to +125°C

Applications

- Set Point or Offset Trimming
- Sensor Calibration
- Precision Selectable Voltage Reference
- Portable Instrumentation (Battery-Powered)
- Calibration of Optical Communication Devices

Block Diagram

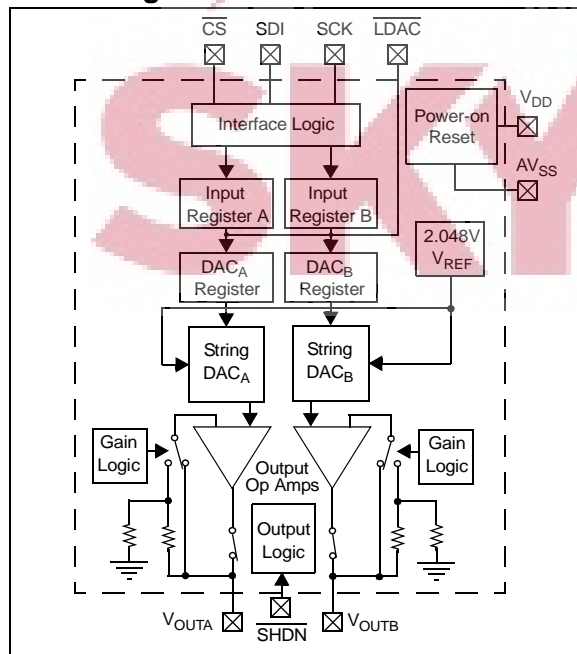

Description

The Microchip Technology Inc. MCP482X devices are 2.7V–5.5V, low-power, low DNL, 12-bit Digital-to-Analog Converters (DACs) with internal band gap voltage reference, optional 2x-buffered output and Serial Peripheral Interface (SPI™).

The MCP482X family of DACs provide high accuracy and low noise performance for industrial applications where calibration or compensation of signals (such as temperature, pressure and humidity) are required.

The MCP482X devices are available in the extended temperature range and PDIP, SOIC and MSOP packages.

The MCP482X devices utilize a resistive string architecture, with its inherent advantages of low DNL error, low ratio metric temperature coefficient and fast settling time. These devices are specified over the extended temperature range. The MCP482X family includes double-buffered registers, allowing simultaneous updates using the \overline{LDAC} pin. These devices also incorporate a Power-On Reset (POR) circuit to ensure reliable power-up.

Package Types

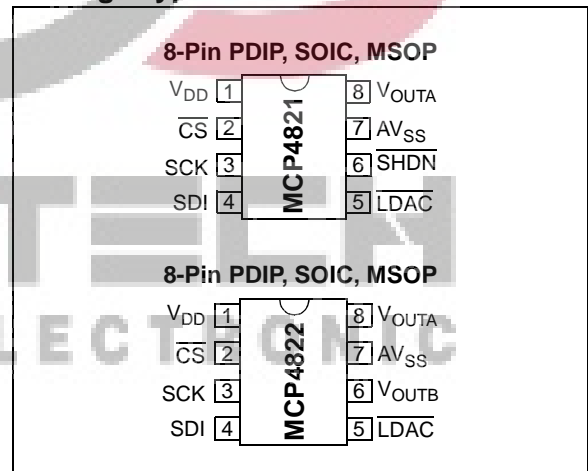

MCP4821/MCP4822

1.0 ELECTRICAL CHARACTERISTICS

Absolute Maximum Ratings †

V_{DD}	6.5V
All inputs and outputs	$AV_{SS} - 0.3V$ to $V_{DD} + 0.3V$
Current at Input Pins	± 2 mA
Current at Supply Pins	± 50 mA
Current at Output Pins	± 25 mA
Storage temperature	$-65^{\circ}C$ to $+150^{\circ}C$
Ambient temp. with power applied	$-55^{\circ}C$ to $+125^{\circ}C$
ESD protection on all pins	≥ 4 kV (HBM), $\geq 400V$ (MM)
Maximum Junction Temperature (T_J)	$+150^{\circ}C$

† **Notice:** Stresses above those listed under “Maximum Ratings” may cause permanent damage to the device. This is a stress rating only and functional operation of the device at those or any other conditions above those indicated in the operational listings of this specification is not implied. Exposure to maximum rating conditions for extended periods may affect device reliability.

5V AC/DC CHARACTERISTICS

Electrical Specifications: Unless otherwise indicated, $V_{DD} = 5V$, $AV_{SS} = 0V$, $V_{REF} = 2.048V$, output buffer gain (G) = 2x, $R_L = 5$ k Ω to GND, $C_L = 100$ pF, $T_A = -40$ to $+85^{\circ}C$. Typical values at $+25^{\circ}C$.						
Parameters	Sym	Min	Typ	Max	Units	Conditions
Power Requirements						
Input Voltage	V_{DD}	2.7	—	5.5		
Input Current - MCP4821 - MCP4822	I_{DD}	—	330 415	400 750	μA	Digital inputs grounded, Output unloaded, code = 0x000
Hardware Shutdown Current	I_{SHDN}	—	0.3	2	μA	
Software Shutdown Current	I_{SHDN_SW}	—	3.3	6	μA	
Power-on-Reset Threshold	V_{POR}	—	2.0	—	V	
DC Accuracy						
Resolution	n	12	—	—	Bits	
INL Error	INL	-12	2	12	LSb	
DNL (Note 1)	DNL	-0.75	± 0.2	+0.75	LSb	Device is monotonic
Offset Error	V_{OS}	-1	± 0.02	1	% of FSR	Code = 0x000h
Offset Error Temperature Coefficient	$V_{OS}/^{\circ}C$	—	0.16	—	ppm/ $^{\circ}C$	$-45^{\circ}C$ to $25^{\circ}C$
		—	-0.44	—	ppm/ $^{\circ}C$	$+25^{\circ}C$ to $85^{\circ}C$
Gain Error	g_E	-2	-0.10	2	% of FSR	Code 0xFFFFh, not including offset error
Gain Error Temperature Coefficient	$\Delta G/^{\circ}C$	—	-3	—	ppm/ $^{\circ}C$	
Internal Voltage Reference (V_{REF})						
Nominal Reference Voltage	V_{REF}	2.008	2.048	2.088	V	V_{OUTA} when G = 1x and Code = 0xFFFFh
Temperature Coefficient (Note 1)	$\Delta V_{REF}/^{\circ}C$	—	125	325	ppm/ $^{\circ}C$	$-40^{\circ}C$ to $0^{\circ}C$
		—	0.25	0.65	LSb/ $^{\circ}C$	$-40^{\circ}C$ to $0^{\circ}C$
		—	45	160	ppm/ $^{\circ}C$	$0^{\circ}C$ to $+85^{\circ}C$
		—	0.09	0.32	LSb/ $^{\circ}C$	$0^{\circ}C$ to $+85^{\circ}C$
Output Noise (V_{REF} Noise)	E_{NREF} (0.1-10 Hz)	—	290	—	μV_{p-p}	Code = 0xFFFFh, G = 1
Output Noise Density	e_{NREF} (1 kHz)	—	1.2	—	$\mu V/\sqrt{Hz}$	Code = 0xFFFFh, G = 1
		—	1.0	—	$\mu V/\sqrt{Hz}$	Code = 0xFFFFh, G = 1
1/f Corner Frequency	f_{CORNER}	—	400	—	Hz	

- Note 1:** By design, not production tested.
Note 2: Too small to quantify.

5V AC/DC CHARACTERISTICS (CONTINUED)

Electrical Specifications: Unless otherwise indicated, $V_{DD} = 5V$, $AV_{SS} = 0V$, $V_{REF} = 2.048V$, output buffer gain (G) = 2x, $R_L = 5\text{ k}\Omega$ to GND, $C_L = 100\text{ pF}$, $T_A = -40$ to $+85^\circ\text{C}$. Typical values at $+25^\circ\text{C}$.

Parameters	Sym	Min	Typ	Max	Units	Conditions
Output Amplifier						
Output Swing	V_{OUT}	—	0.010 to $V_{DD} - 0.040$	—		Accuracy is better than 1 LSB for $V_{OUT} = 10\text{ mV}$ to $(V_{DD} - 40\text{ mV})$
Phase Margin	PM	—	66	—	°	
Slew Rate	SR	—	0.55	—	V/ μs	
Short Circuit Current	I_{SC}	—	15	24	mA	
Settling Time	$t_{SETTLING}$	—	4.5	—	μs	Within 1/2 LSB of final value from 1/4 to 3/4 full-scale range
Dynamic Performance						
DAC-to-DAC Crosstalk		—	<10	—	nV-s	Note 2
Major Code Transition Glitch		—	45	—	nV-s	1 LSB change around major carry (0111...1111 to 1000...0000)
Digital Feedthrough		—	<10	—	nV-s	Note 2
Analog Crosstalk		—	<10	—	nV-s	Note 2

Note 1: By design, not production tested.

Note 2: Too small to quantify.

3V AC/DC CHARACTERISTICS

Electrical Specifications: Unless otherwise indicated, $V_{DD} = 3V$, $AV_{SS} = 0V$, $V_{REF} = 2.048V$ external, output buffer gain (G) = 1x, $R_L = 5\text{ k}\Omega$ to GND, $C_L = 100\text{ pF}$, $T_A = -40$ to $+85^\circ\text{C}$. Typical values at 25°C

Parameters	Sym	Min	Typ	Max	Units	Conditions
Power Requirements						
Input Voltage	V_{DD}	2.7	—	5.5		
Input Current - MCP4821 - MCP4822	I_{DD}	—	300 415	400 750	μA	Digital inputs grounded, Output unloaded, code = 0x000
Hardware Shutdown Current	I_{SHDN}	—	0.25	2	μA	
Software Shutdown Current	I_{SHDN_SW}	—	2	6	μA	
Power-On Reset threshold	V_{POR}	—	2.0	—	V	
DC Accuracy						
Resolution	n	12	—	—	Bits	
INL Error	INL	-12	± 3	12	LSb	
DNL (Note 1)	DNL	-0.75	± 0.3	0.75	LSb	Device is monotonic
Offset Error	V_{OS}	-1	± 0.02	1	% of FSR	Code 0x000h
Offset Error Temperature Coefficient	$V_{OS}/^\circ\text{C}$	—	0.5	—	ppm/ $^\circ\text{C}$	-45 $^\circ\text{C}$ to +25 $^\circ\text{C}$
		—	-0.77	—	ppm/ $^\circ\text{C}$	+25 $^\circ\text{C}$ to +85 $^\circ\text{C}$
Gain Error	g_E	-2	-0.15	2	% of FSR	Code 0xFFFFh, not including offset error
Gain Error Temperature Coefficient	$\Delta G/^\circ\text{C}$	—	-3	—	ppm/ $^\circ\text{C}$	

Note 1: By design, not production tested.

Note 2: Too small to quantify.

MCP4821/MCP4822

3V AC/DC CHARACTERISTICS (CONTINUED)

Electrical Specifications: Unless otherwise indicated, $V_{DD} = 3V$, $AV_{SS} = 0V$, $V_{REF} = 2.048V$ external, output buffer gain (G) = 1x, $R_L = 5\text{ k}\Omega$ to GND, $C_L = 100\text{ pF}$, $T_A = -40$ to $+85^\circ\text{C}$. Typical values at 25°C

Parameters	Sym	Min	Typ	Max	Units	Conditions
Internal Voltage Reference (V_{REF})						
Nominal Reference Voltage	V_{REF}	2.008	2.048	2.088	V	V_{OUTA} when $G = 1x$ and Code = 0xFFFFh
Temperature Coefficient (Note 1)	$\Delta V_{REF}/^\circ\text{C}$	—	125	325	ppm/ $^\circ\text{C}$	-40°C to 0°C
		—	0.25	0.65	LSb/ $^\circ\text{C}$	-40°C to 0°C
		—	45	160	ppm/ $^\circ\text{C}$	0°C to $+85^\circ\text{C}$
		—	0.09	0.32	LSb/ $^\circ\text{C}$	0°C to $+85^\circ\text{C}$
Output Noise (V_{REF} Noise)	E_{NREF} (0.1-10 Hz)	—	290	—	μV_{p-p}	Code = 0xFFFFh, $G = 1$
Output Noise Density	e_{NREF} (1 kHz)	—	1.2	—	$\mu\text{V}/\sqrt{\text{Hz}}$	Code = 0xFFFFh, $G = 1$
		—	1.0	—	$\mu\text{V}/\sqrt{\text{Hz}}$	Code = 0xFFFFh, $G = 1$
1/f Corner Frequency	f_{CORNER}	—	400	—	Hz	
Output Amplifier						
Output Swing	V_{OUT}	—	0.010 to $V_{DD} - 0.040$	—		Accuracy is better than 1 LSb for $V_{OUT} = 10\text{ mV}$ to $(V_{DD} - 40\text{ mV})$
Phase Margin	PM	—	66	—	$^\circ$	
Slew Rate	SR	—	0.55	—	V/ μs	
Short Circuit Current	I_{SC}	—	14	24	mA	
Settling Time	$t_{SETTLING}$	—	4.5	—	μs	Within 1/2 LSb of final value from 1/4 to 3/4 full-scale range
Dynamic Performance						
DAC-to-DAC Crosstalk		—	<10	—	nV-s	Note 2
Major Code Transition Glitch		—	45	—	nV-s	1 LSb change around major carry (0111...1111 to 1000...0000)
Digital Feedthrough		—	<10	—	nV-s	Note 2
Analog Crosstalk		—	<10	—	nV-s	Note 2

Note 1: By design, not production tested.

Note 2: Too small to quantify.

5V EXTENDED TEMPERATURE SPECIFICATIONS

Electrical Specifications: Unless otherwise indicated, $V_{DD} = 5V$, $AV_{SS} = 0V$, $V_{REF} = 2.048V$, output buffer gain (G) = 2x, $R_L = 5\text{ k}\Omega$ to GND, $C_L = 100\text{ pF}$. Typical values at $+125^\circ\text{C}$ by characterization or simulation.

Parameters	Sym	Min	Typ	Max	Units	Conditions
Power Requirements						
Input Voltage	V_{DD}	2.7	—	5.5		
Input Current - MCP4821 - MCP4822	I_{DD}	—	350 440	—	μA	Digital inputs grounded, Output unloaded, code = 0x000
Hardware Shutdown Current	I_{SHDN}	—	1.5	—	μA	
Software Shutdown Current	I_{SHDN_SW}	—	5	—	μA	
Power-On Reset threshold	V_{POR}	—	1.85	—	V	
DC Accuracy						
Resolution	n	12	—	—	Bits	
INL Error	INL	—	± 4	—	LSb	

Note 1: By design, not production tested.

Note 2: Too small to quantify.

5V EXTENDED TEMPERATURE SPECIFICATIONS (CONTINUED)

Electrical Specifications: Unless otherwise indicated, $V_{DD} = 5V$, $AV_{SS} = 0V$, $V_{REF} = 2.048V$, output buffer gain (G) = 2x, $R_L = 5\text{ k}\Omega$ to GND, $C_L = 100\text{ pF}$. Typical values at +125°C by characterization or simulation.

Parameters	Sym	Min	Typ	Max	Units	Conditions
DNL (Note 1)	DNL	—	±0.25	—	LSb	Device is monotonic
Offset Error	V_{OS}	—	±0.02	—	% of FSR	Code 0x000h
Offset Error Temperature Coefficient	$V_{OS}/^{\circ}\text{C}$	—	-5	—	ppm/ $^{\circ}\text{C}$	+25°C to +125°C
Gain Error	g_E	—	-0.10	—	% of FSR	Code 0xFFFFh, not including offset error
Gain Error Temperature Coefficient	$\Delta G/^{\circ}\text{C}$	—	-3	—	ppm/ $^{\circ}\text{C}$	
Internal Voltage Reference (V_{REF})						
Nominal Reference Voltage	V_{REF}	—	2.048	—	V	V_{OUTA} when $G = 1x$ and Code = 0xFFFFh
Temperature Coefficient (Note 1)	$\Delta V_{REF}/^{\circ}\text{C}$	—	125	—	ppm/ $^{\circ}\text{C}$	-40°C to 0°C
		—	0.25	—	LSb/ $^{\circ}\text{C}$	-40°C to 0°C
		—	45	—	ppm/ $^{\circ}\text{C}$	0°C to +85°C
		—	0.09	—	LSb/ $^{\circ}\text{C}$	0°C to +85°C
Output Noise (V_{REF} Noise)	E_{NREF} (0.1 - 10 Hz)	—	290	—	μV_{p-p}	Code = 0xFFFFh, $G = 1$
Output Noise Density	e_{NREF} (1 kHz)	—	1.2	—	$\mu\text{V}/\sqrt{\text{Hz}}$	Code = 0xFFFFh, $G = 1$
		e_{NREF} (10 kHz)	—	1.0	—	$\mu\text{V}/\sqrt{\text{Hz}}$
1/f Corner Frequency	f_{CORNER}	—	400	—	Hz	
Output Amplifier						
Output Swing	V_{OUT}	—	0.010 to $V_{DD}-0.040$	—		Accuracy is better than 1 LSB for $V_{OUT} = 10\text{ mV}$ to ($V_{DD} - 40\text{ mV}$)
Phase Margin	PM	—	66	—	$^{\circ}$	
Slew Rate	SR	—	0.55	—	V/ μs	
Short Circuit Current	I_{SC}	—	17	—	mA	
Settling Time	$t_{SETTLING}$	—	4.5	—	μs	Within 1/2 LSB of final value from 1/4 to 3/4 full-scale range
Dynamic Performance						
DAC-to-DAC Crosstalk		—	<10	—	nV-s	Note 2
Major Code Transition Glitch		—	45	—	nV-s	1 LSB change around major carry (0111...1111 to 1000...0000)
Digital Feedthrough		—	<10	—	nV-s	Note 2
Analog Crosstalk		—	<10	—	nV-s	Note 2

Note 1: By design, not production tested.

Note 2: Too small to quantify.

MCP4821/MCP4822

AC CHARACTERISTICS (SPI™ TIMING SPECIFICATIONS)

Electrical Specifications: Unless otherwise indicated, $V_{DD} = 2.7V - 5.5V$, $T_A = -40$ to $+125^\circ C$.
Typical values are at $+25^\circ C$.

Parameters	Sym	Min	Typ	Max	Units	Conditions
Schmitt Trigger High-Level Input Voltage (All digital input pins)	V_{IH}	$0.7 V_{DD}$	—	—	V	
Schmitt Trigger Low-Level Input Voltage (All digital input pins)	V_{IL}	—	—	$0.2 V_{DD}$	V	
Hysteresis of Schmitt Trigger Inputs	V_{HYS}	—	$0.05 V_{DD}$	—		
Input Leakage Current	$I_{LEAKAGE}$	-1	—	1	μA	$\overline{SHDN} = \overline{LDAC} = \overline{CS} = \overline{SDI} = \overline{SCK} + V_{REF} = V_{DD}$ or AV_{SS}
Digital Pin Capacitance (All inputs/outputs)	C_{IN}, C_{OUT}	—	10	—	pF	$V_{DD} = 5.0V$, $T_A = +25^\circ C$, $f_{CLK} = 1$ MHz (Note 1)
Clock Frequency	F_{CLK}	—	—	20	MHz	$T_A = +25^\circ C$ (Note 1)
Clock High Time	t_{HI}	15	—	—	ns	Note 1
Clock Low Time	t_{LO}	15	—	—	ns	Note 1
\overline{CS} Fall to First Rising CLK Edge	t_{CSSR}	40	—	—	ns	Applies only when \overline{CS} falls with CLK high. (Note 1)
Data Input Setup Time	t_{SU}	15	—	—	ns	Note 1
Data Input Hold Time	t_{HD}	10	—	—	ns	Note 1
SCK Rise to \overline{CS} Rise Hold Time	t_{CHS}	15	—	—	ns	Note 1
\overline{CS} High Time	t_{CSH}	15	—	—	ns	Note 1
LDAC Pulse Width	t_{LD}	100	—	—	ns	Note 1
LDAC Setup Time	t_{LS}	40	—	—	ns	Note 1
SCK Idle Time before \overline{CS} Fall	t_{IDLE}	40	—	—	ns	Note 1

Note 1: By design and characterization, not production tested.

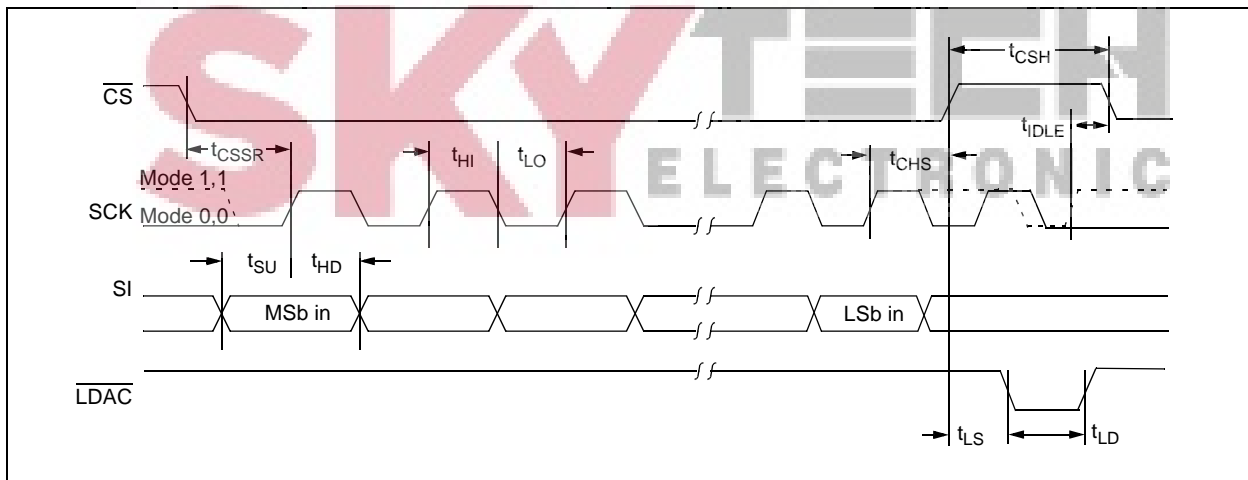

FIGURE 1-1: SPI™ Input Timing.

TEMPERATURE CHARACTERISTICS

Electrical Specifications: Unless otherwise indicated, $V_{DD} = +2.7V$ to $+5.5V$, $AV_{SS} = GND$.						
Parameters	Sym	Min	Typ	Max	Units	Conditions
Temperature Ranges						
Specified Temperature Range	T_A	-40	—	+125	°C	
Operating Temperature Range	T_A	-40	—	+125	°C	Note 1
Storage Temperature Range	T_A	-65	—	+150	°C	
Thermal Package Resistances						
Thermal Resistance, 8L-PDIP	θ_{JA}	—	85	—	°C/W	
Thermal Resistance, 8L-SOIC	θ_{JA}	—	163	—	°C/W	
Thermal Resistance, 8L-MSOP	θ_{JA}	—	206	—	°C/W	

Note 1: The MCP482X family of DACs operate over this extended temperature range, but with reduced performance. Operation in this range must not cause T_J to exceed the Maximum Junction Temperature of $+150^\circ\text{C}$.



MCP4821/MCP4822

2.0 TYPICAL PERFORMANCE CURVES

Note: The graphs and tables provided following this note are a statistical summary based on a limited number of samples and are provided for informational purposes only. The performance characteristics listed herein are not tested or guaranteed. In some graphs or tables, the data presented may be outside the specified operating range (e.g., outside specified power supply range) and therefore outside the warranted range.

Note: Unless otherwise indicated, $T_A = +25^\circ\text{C}$, $V_{DD} = 5\text{V}$, $A_{V_{SS}} = 0\text{V}$, $V_{REF} = 2.048\text{V}$, $\text{Gain} = 2$, $R_L = 5\text{ k}\Omega$, $C_L = 100\text{ pF}$.

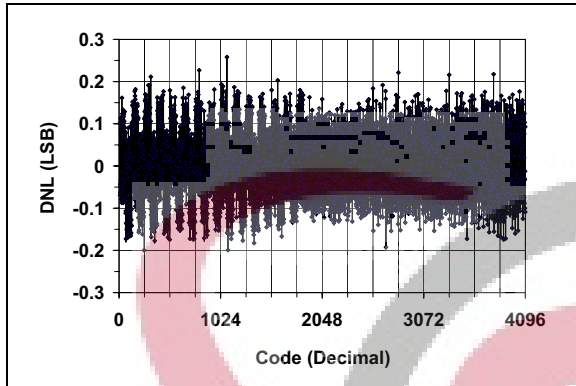

FIGURE 2-1: DNL vs. Code.

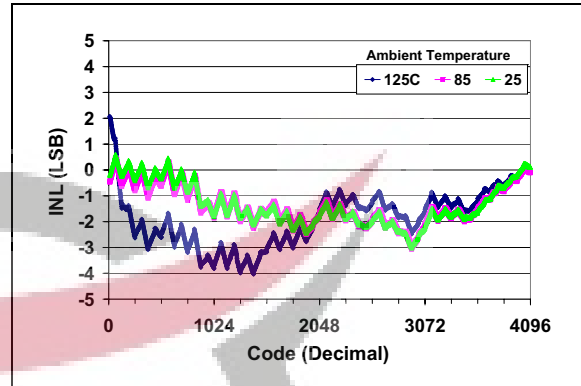

FIGURE 2-4: INL vs. Code and Ambient Temperature.

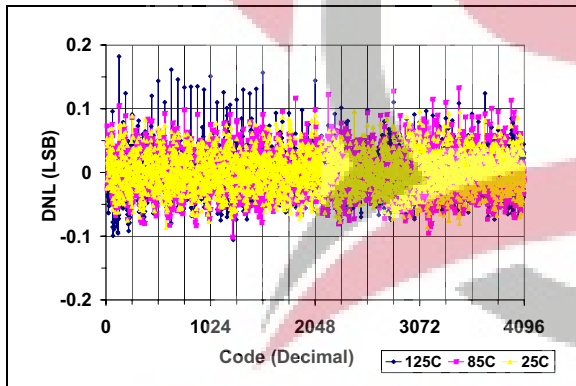

FIGURE 2-2: DNL vs. Code and Ambient Temperature.

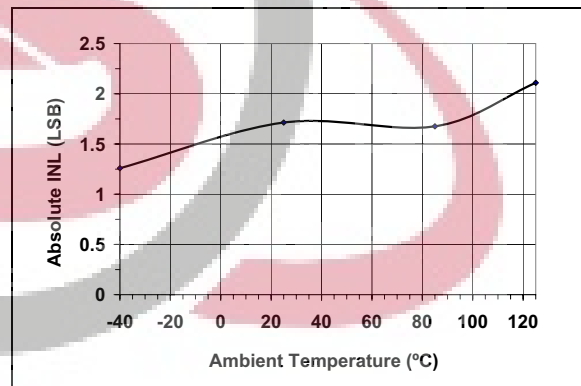

FIGURE 2-5: Absolute INL vs. Ambient Temperature.

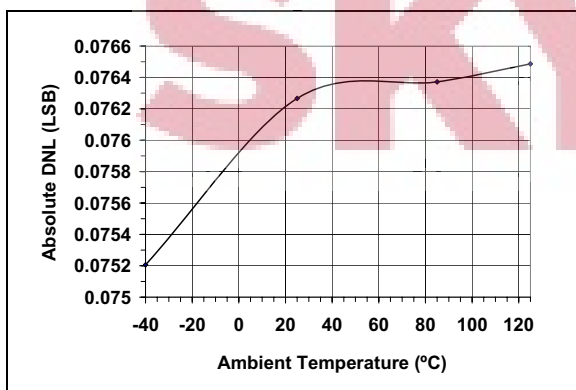

FIGURE 2-3: Absolute DNL vs. Ambient Temperature.

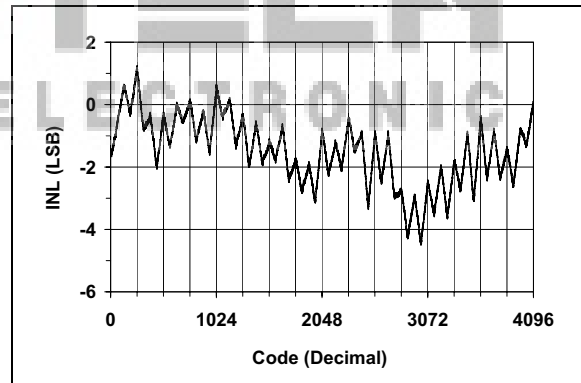

FIGURE 2-6: INL vs. Code.

Note: Single device graph for illustration of 64 code effect.

Note: Unless otherwise indicated, $T_A = +25^\circ\text{C}$, $V_{DD} = 5\text{V}$, $A_{V_{SS}} = 0\text{V}$, $V_{REF} = 2.048\text{V}$, Gain = 2, $R_L = 5\text{ k}\Omega$, $C_L = 100\text{ pF}$.

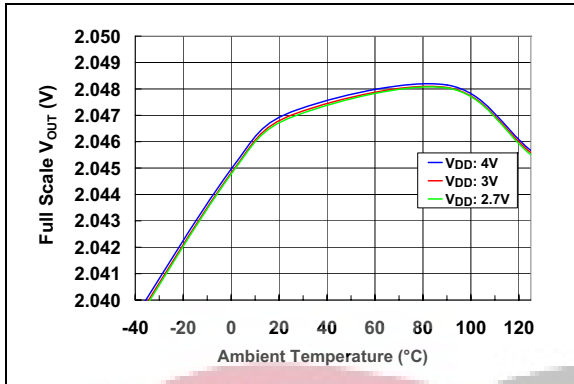

FIGURE 2-7: Full-Scale V_{OUTA} w/G = 1 (V_{REF}) vs. Ambient Temperature and V_{DD} .

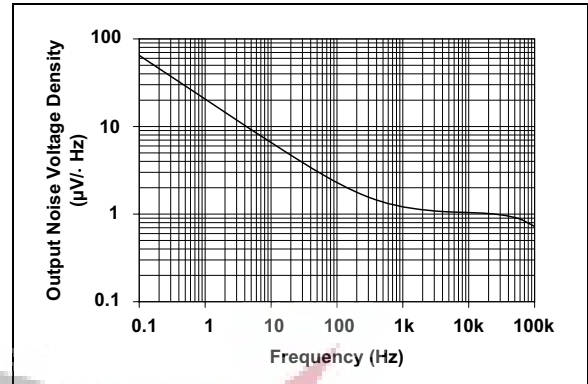

FIGURE 2-9: Output Noise Voltage Density (V_{REF} Noise Density w/G = 1) vs. Frequency.

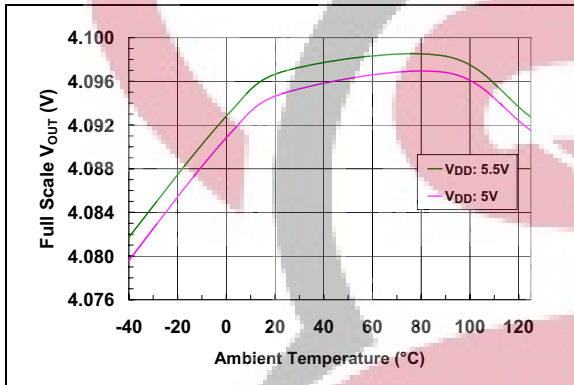

FIGURE 2-8: Full-Scale V_{OUTA} w/G = 2 ($2V_{REF}$) vs. Ambient Temperature and V_{DD} .

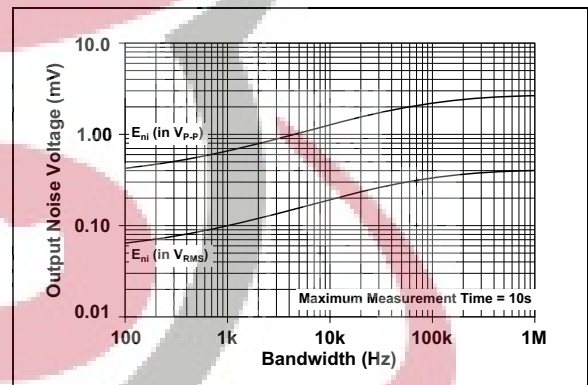

FIGURE 2-10: Output Noise Voltage (V_{REF} Noise Voltage w/G = 1) vs. Bandwidth.



MCP4821/MCP4822

Note: Unless otherwise indicated, $T_A = +25^\circ\text{C}$, $V_{DD} = 5\text{V}$, $AV_{SS} = 0\text{V}$, $V_{REF} = 2.048\text{V}$, Gain = 2, $R_L = 5\text{ k}\Omega$, $C_L = 100\text{ pF}$.

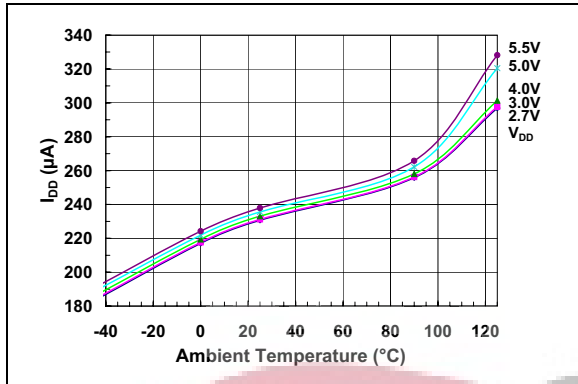

FIGURE 2-11: MCP4821 I_{DD} vs. Ambient Temperature and V_{DD} .

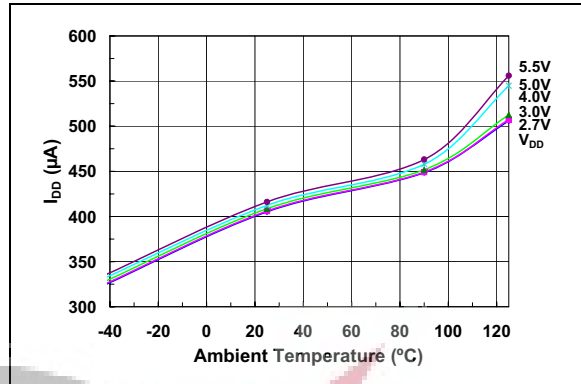

FIGURE 2-14: MCP4822 I_{DD} vs. Ambient Temperature and V_{DD} .

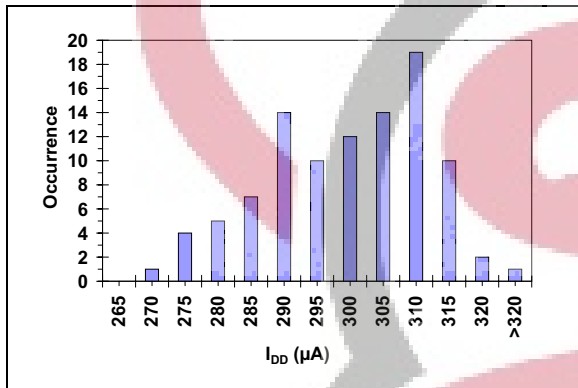

FIGURE 2-12: MCP4821 I_{DD} Histogram ($V_{DD} = 2.7\text{V}$).

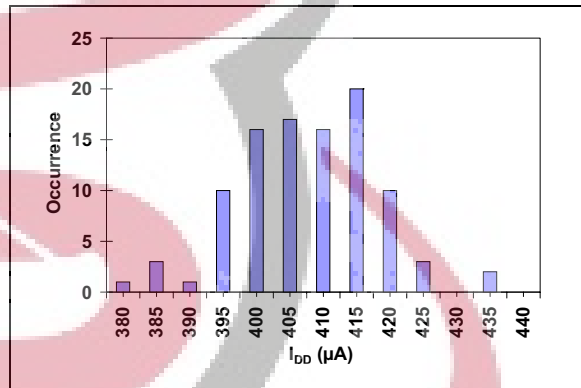

FIGURE 2-15: MCP4822 I_{DD} Histogram ($V_{DD} = 2.7\text{V}$).

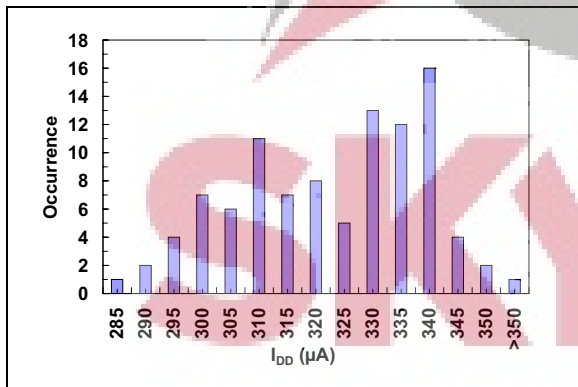

FIGURE 2-13: MCP4821 I_{DD} Histogram ($V_{DD} = 5.0\text{V}$).

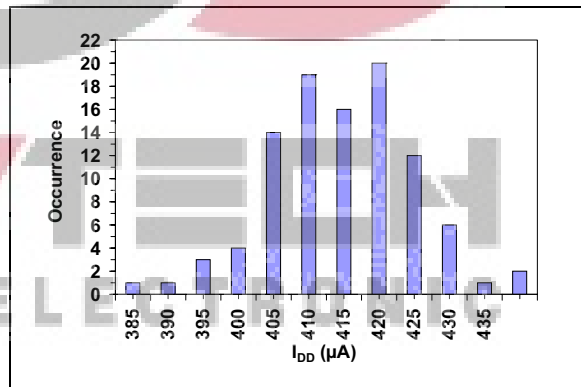

FIGURE 2-16: MCP4822 I_{DD} Histogram ($V_{DD} = 5.0\text{V}$).

Note: Unless otherwise indicated, $T_A = +25^\circ\text{C}$, $V_{DD} = 5\text{V}$, $A_{V_{SS}} = 0\text{V}$, $V_{REF} = 2.048\text{V}$, Gain = 2, $R_L = 5\text{ k}\Omega$, $C_L = 100\text{ pF}$.

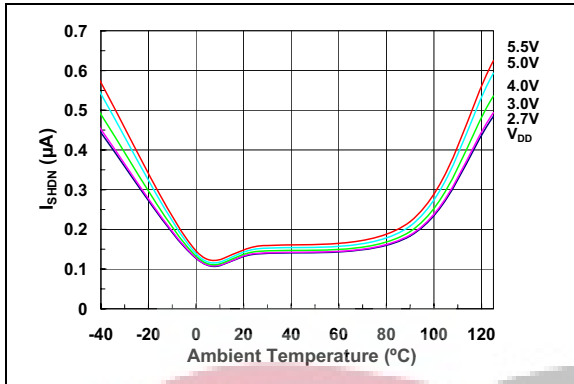

FIGURE 2-17: Hardware Shutdown Current vs. Ambient Temperature and V_{DD} .

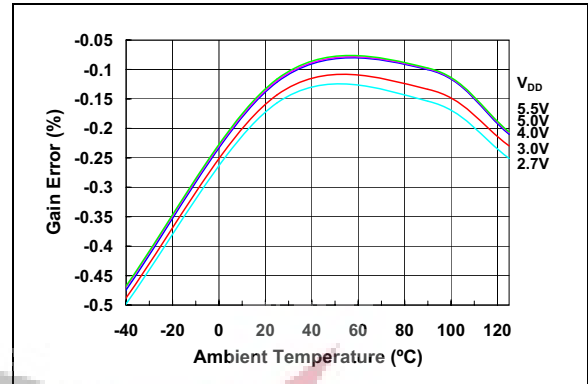

FIGURE 2-20: Gain Error vs. Ambient Temperature and V_{DD} .

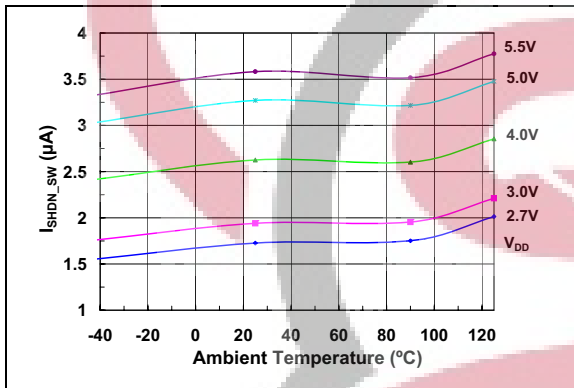

FIGURE 2-18: Software Shutdown Current vs. Ambient Temperature and V_{DD} .

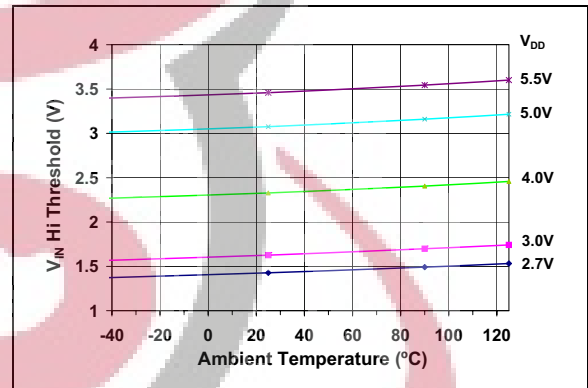

FIGURE 2-21: V_{IN} High Threshold vs. Ambient Temperature and V_{DD} .

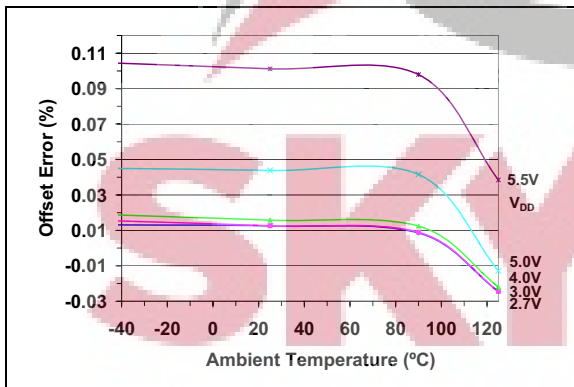

FIGURE 2-19: Offset Error vs. Ambient Temperature and V_{DD} .

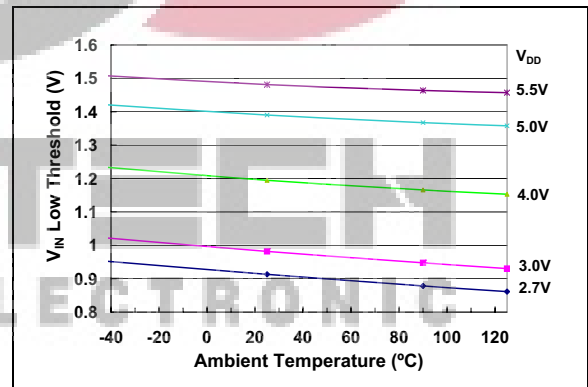

FIGURE 2-22: V_{IN} Low Threshold vs. Ambient Temperature and V_{DD} .

MCP4821/MCP4822

Note: Unless otherwise indicated, $T_A = +25^\circ\text{C}$, $V_{DD} = 5\text{V}$, $AV_{SS} = 0\text{V}$, $V_{REF} = 2.048\text{V}$, $\text{Gain} = 2$, $R_L = 5\text{ k}\Omega$, $C_L = 100\text{ pF}$.

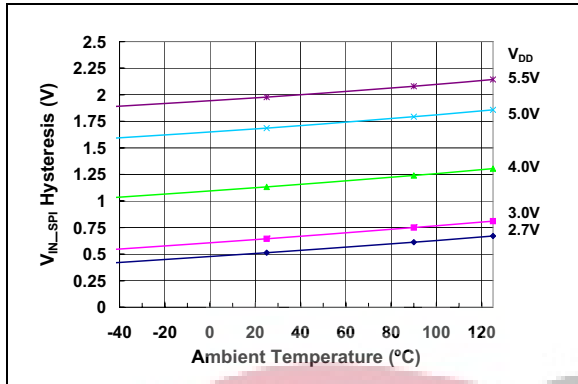

FIGURE 2-23: V_{m_spl} Hysteresis vs. Ambient Temperature and V_{DD} .

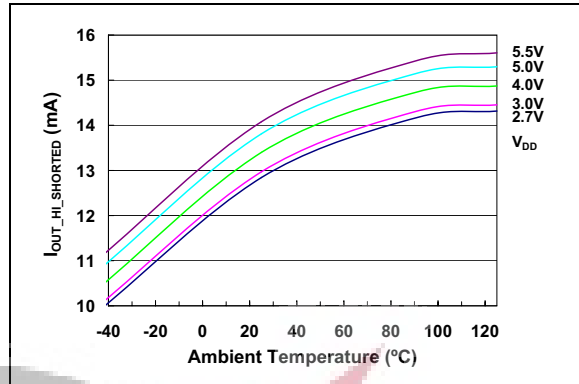

FIGURE 2-26: $I_{OUT_HI_SHORTED}$ vs. Ambient Temperature and V_{DD} .

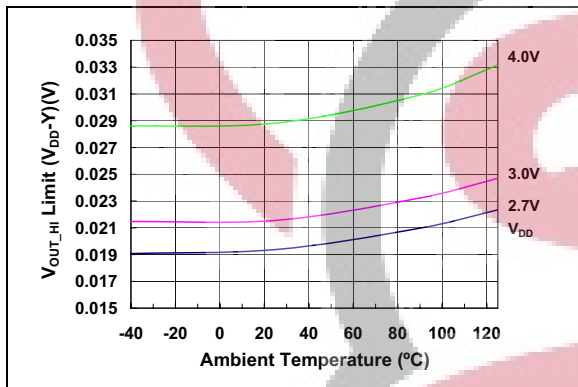

FIGURE 2-24: V_{OUT_HI} Limit vs. Ambient Temperature and V_{DD} .

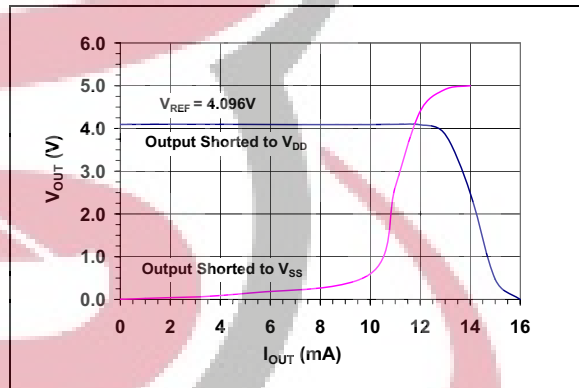

FIGURE 2-27: I_{OUT} vs. V_{OUT} . $\text{Gain} = 2$.

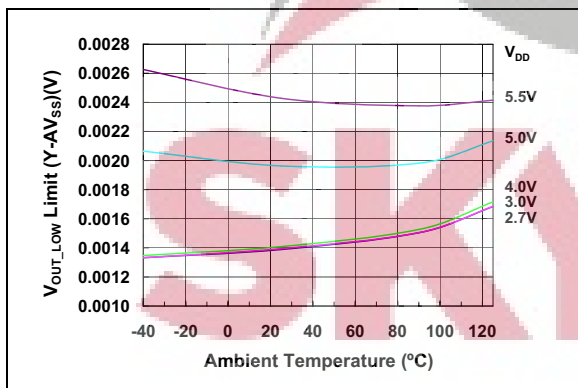

FIGURE 2-25: V_{OUT_LOW} Limit vs. Ambient Temperature and V_{DD} .

SKYTECH
ELECTRONIC

MCP4821/MCP4822

Note: Unless otherwise indicated, $T_A = +25^\circ\text{C}$, $V_{DD} = 5\text{V}$, $AV_{SS} = 0\text{V}$, $V_{REF} = 2.048\text{V}$, Gain = 2, $R_L = 5\text{ k}\Omega$, $C_L = 100\text{ pF}$.

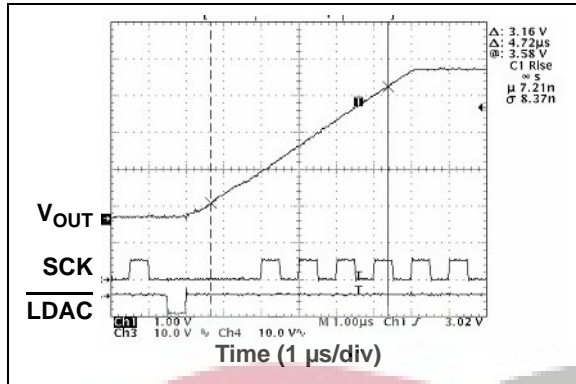

FIGURE 2-28: V_{OUT} Rise Time 100%.

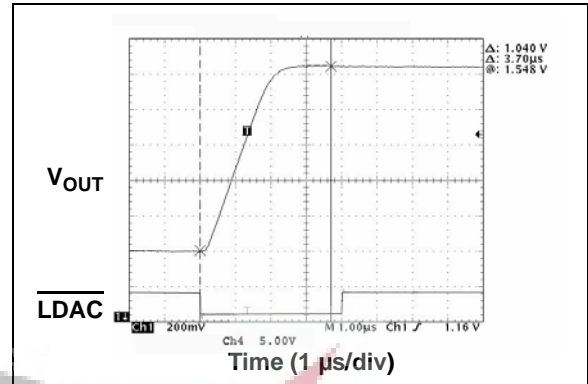

FIGURE 2-31: V_{OUT} Rise Time 25% - 75%.

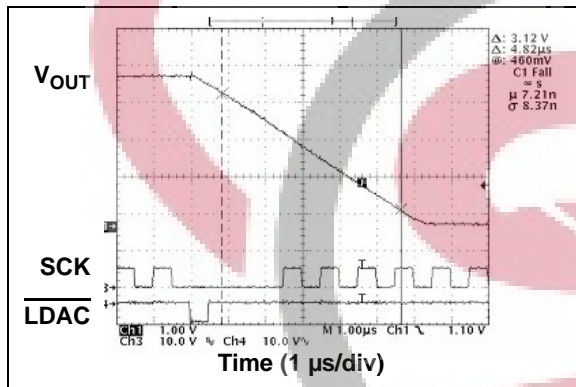

FIGURE 2-29: V_{OUT} Fall Time.

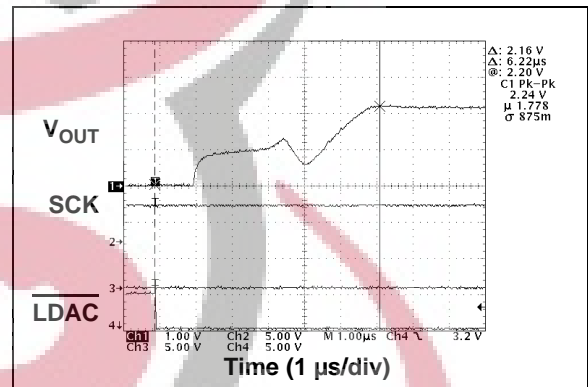

FIGURE 2-32: V_{OUT} Rise Time Exit Shutdown.

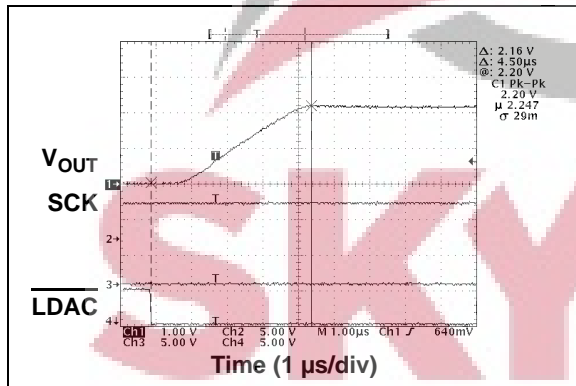

FIGURE 2-30: V_{OUT} Rise Time 50%.

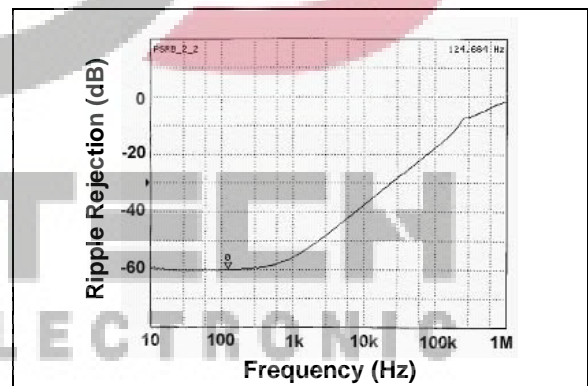

FIGURE 2-33: PSRR vs. Frequency.

MCP4821/MCP4822

3.0 PIN DESCRIPTIONS

The descriptions of the pins are listed in Table 3-1.

TABLE 3-1: PIN FUNCTION TABLE

MCP4821 Pin No.	MCP4822 Pin No.	Symbol	Function
1	1	V_{DD}	Positive Power Supply Input (2.7V to 5.5V)
2	2	\overline{CS}	Chip Select Input
3	3	SCK	Serial Clock Input
4	4	SDI	Serial Data Input
5	5	\overline{LDAC}	Synchronization input used to transfer DAC settings from serial latches to output latches
6	—	\overline{SHDN}	Hardware Shutdown Input
—	6	V_{OUTB}	DAC _B Output
7	7	AV_{SS}	Analog Ground
8	8	V_{OUTA}	DAC _A Output

3.1 Positive Power Supply Input (V_{DD})

V_{DD} is the positive power supply input. The input power supply is relative to AV_{SS} and can range from 2.7V to 5.5V. A decoupling capacitor on V_{DD} is recommended to achieve maximum performance.

3.2 Chip Select (\overline{CS})

\overline{CS} is the chip select input, which requires an active-low signal to enable serial clock and data functions.

3.3 Serial Clock Input (SCK)

SCK is the SPI compatible serial clock input.

3.4 Serial Data Input (SDI)

SDI is the SPI compatible serial data input.

3.5 Latch DAC Input (\overline{LDAC})

\overline{LDAC} (the latch DAC synchronization input) transfers the input latch registers to the DAC registers (output latches) when low. Can also be tied low if transfer on the rising edge of \overline{CS} is desired.

3.6 Hardware Shutdown Input (\overline{SHDN})

\overline{SHDN} is the hardware shutdown input that requires an active-low input signal to configure the DACs in their low-power Standby mode.

3.7 DAC_x Outputs (V_{OUTA} , V_{OUTB})

V_{OUTA} and V_{OUTB} are DAC outputs. The DAC output amplifier drives these pins with a range of AV_{SS} to V_{DD} .

3.8 Analog Ground (AV_{SS})

AV_{SS} is the analog ground pin.

4.0 GENERAL OVERVIEW

The MCP482X devices are voltage-output string DACs. These devices include rail-to-rail output amplifiers, internal voltage reference, shutdown and reset-management circuitry. Serial communication conforms to the SPI protocol. The MCP482X devices operate from 2.7V to 5.5V supplies.

The coding of these devices is straight binary, with the ideal output voltage given by Equation 4-1, where G is the selected gain (1x or 2x), D_N represents the digital input value and n represents the number of bits of resolution ($n = 12$).

EQUATION 4-1: LSb SIZE

$$V_{OUT} = \frac{2.048V \cdot G \cdot D_N}{2^n}$$

1 LSb is the ideal voltage difference between two successive codes. Table 4-1 illustrates how to calculate LSb.

TABLE 4-1: LSb SIZES

Device	Gain	LSb Size
MCP482X	1x	2.048V/4096
MCP482X	2x	4.096V/4096

4.0.1 INL ACCURACY

INL error for these devices is the maximum deviation between an actual code transition point and its corresponding ideal transition point once offset and gain errors have been removed. These endpoints are from 0x000 to 0xFFF. Refer to Figure 4-1.

Positive INL represents transition(s) later than ideal. Negative INL represents transition(s) earlier than ideal.

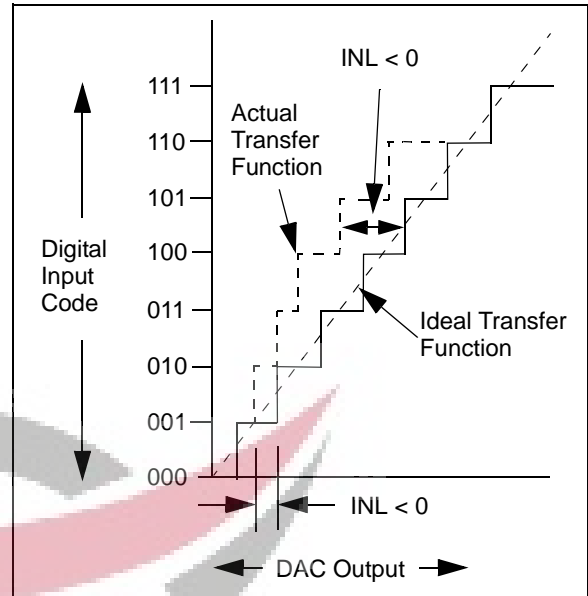

FIGURE 4-1: INL Accuracy.

4.0.2 DNL ACCURACY

DNL error is the measure of variations in code widths from the ideal code width. A DNL error of zero would imply that every code is exactly 1 LSb wide.

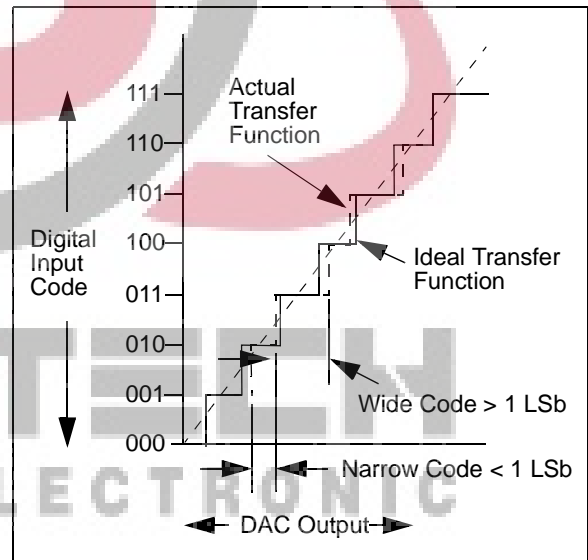

FIGURE 4-2: DNL Accuracy.

4.0.3 OFFSET ERROR

Offset error is the deviation from zero voltage output when the digital input code is zero.

4.0.4 GAIN ERROR

Gain error is the deviation from the ideal output, $V_{REF} - 1 \text{ LSb}$, excluding the effects of offset error.

MCP4821/MCP4822

4.1 Circuit Descriptions

4.1.1 OUTPUT AMPLIFIERS

The DACs' outputs are buffered with a low-power, precision CMOS amplifier. This amplifier provides low offset voltage and low noise. The output stage enables the device to operate with output voltages close to the power supply rails. Refer to **Section 1.0 "Electrical Characteristics"** for range and load conditions.

In addition to resistive load-driving capability, the amplifier will also drive high capacitive loads without oscillation. The amplifiers' strong outputs allow V_{OUT} to be used as a programmable voltage reference in a system.

4.1.1.1 Programmable Gain Block

The rail-to-rail output amplifier has configurable gain, allowing optimal full-scale outputs for differing voltage reference inputs. The output amplifier gain has two selections, a gain of 1 V/V ($\overline{GA} = 1$) or a gain of 2 V/V ($\overline{GA} = 0$).

The output range is ideally 0.000V to $4095/4096 * 2.048V$ when $G = 1$, and 0.000 to $4095/4096 * 4.096V$ when $G = 2$. The default value for this bit is a gain of 2, yielding an ideal full-scale output of 0.000V to 4.096V due to the internal 2.048V V_{REF} . Note that the near rail-to-rail CMOS output buffer's ability to approach AV_{SS} and V_{DD} establish practical range limitations. The output swing specification in **Section 1.0 "Electrical Characteristics"** defines the range for a given load condition.

4.1.2 VOLTAGE REFERENCE

The MCP482X devices utilize internal 2.048V voltage reference. The voltage reference has low temperature coefficient and low noise characteristics. Refer to **Section 1.0 "Electrical Characteristics"** for the voltage reference specifications.

4.1.3 POWER-ON RESET CIRCUIT

The Power-On Reset (POR) circuit ensures that the DACs power-up with $\overline{SHDN} = 0$ (high-impedance). The devices will continue to have a high-impedance output until a valid Write command is performed to either of the DAC registers and the \overline{LDAC} pin meets the input low threshold.

If the power supply voltage is less than the POR threshold ($V_{POR} = 2.0V$, typical), the DACs will be held in their reset state. They will remain in that state until $V_{DD} > V_{POR}$ and a subsequent Write command is received.

Figure 4-3 shows a typical power supply transient pulse and the duration required to cause a reset to occur, as well as the relationship between the duration and trip voltage. A 0.1 μF decoupling capacitor, mounted as close as possible to the V_{DD} pin, provides additional transient immunity.

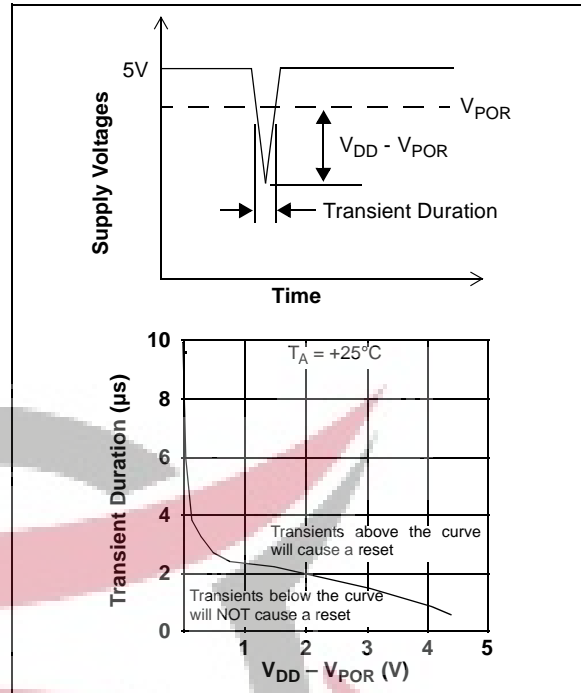

FIGURE 4-3: Typical Transient Response.

4.1.4 SHUTDOWN MODE

Shutdown mode can be entered by using either hardware or software commands. The hardware pin (\overline{SHDN}) is only available on the MCP4821. During Shutdown mode, the supply current is isolated from most of the internal circuitry. The serial interface remains active, thus allowing a Write command to bring the device out of Shutdown mode. When the output amplifiers are shut down, the feedback resistance (typically 500 k Ω) produces a high-impedance path to AV_{SS} . The device will remain in Shutdown mode until the \overline{SHDN} pin is brought high and a write command with $\overline{SD} = 1$ is latched into the device. When a DAC is changed from Shutdown to Active mode, the output settling time takes $< 10 \mu s$, but greater than the standard Active mode settling time (4.5 μs).

5.0 SERIAL INTERFACE

5.1 Overview

The MCP482X family is designed to interface directly with the SPI port, available on many microcontrollers, and supports Mode 0,0 and Mode 1,1. Commands and data are sent to the device via the SDI pin, with data being clocked-in on the rising edge of SCK. The communications are unidirectional and, thus, data cannot be read out of the MCP482X devices. The \overline{CS} pin must be held low for the duration of a write command. The write command consists of 16 bits and is used to configure the DAC's control and data latches. Register 5-1 details the input registers used to configure and load the DAC_A and DAC_B registers. Refer to Figure 1-1 and the AC Electrical Characteristics tables for detailed input and output timing specifications for both Mode 0,0 and Mode 1,1 operation.

5.2 Write Command

The write command is initiated by driving the \overline{CS} pin low, followed by clocking the four configuration bits and the 12 data bits into the SDI pin on the rising edge of SCK. The \overline{CS} pin is then raised, causing the data to be latched into the selected DAC's input registers. The MCP482X devices utilize a double-buffered latch structure to allow both DAC_A's and DAC_B's outputs to be synchronized with the LDAC pin, if desired. Upon the LDAC pin achieving a low state, the values held in the DAC's input registers are transferred into the DACs' output registers. The outputs will transition to the value and held in the DAC_X register.

All writes to the MCP482X devices are 16-bit words. Any clocks past 16 will be ignored. The most significant four bits are configuration bits. The remaining 12 bits are data bits. No data can be transferred into the device with \overline{CS} high. This transfer will only occur if 16 clocks have been transferred into the device. If the rising edge of \overline{CS} occurs prior, shifting of data into the input registers will be aborted.

REGISTER 5-1: WRITE COMMAND REGISTER

Upper Half:							
W-x	W-x	W-x	W-0	W-x	W-x	W-x	W-x
$\overline{A/B}$	—	\overline{GA}	\overline{SHDN}	D11	D10	D9	D8
bit 15				bit 8			

Lower Half:							
W-x	W-x	W-x	W-x	W-x	W-x	W-x	W-x
D7	D6	D5	D4	D3	D2	D1	D0
bit 7				bit 0			

bit 15 $\overline{A/B}$: DAC_A or DAC_B Select bit

1 = Write to DAC_B

0 = Write to DAC_A

bit 14 — Don't Care

bit 13 \overline{GA} : Output Gain Select bit

1 = 1x ($V_{OUT} = V_{REF} * D/4096$)

0 = 2x ($V_{OUT} = 2 * V_{REF} * D/4096$)

bit 12 \overline{SHDN} : Output Power-down Control bit

1 = Output Power-down Control bit

0 = Output buffer disabled, Output is high-impedance

bit 11-0 **D11:D0**: DAC Data bits

12-bit number "D" which sets the output value. Contains a value between 0 and 4095.

Legend

R = Readable bit

W = Writable bit

U = Unimplemented bit, read as '0'

-n = Value at POR

1 = bit is set

0 = bit is cleared

x = bit is unknown

MCP4821/MCP4822

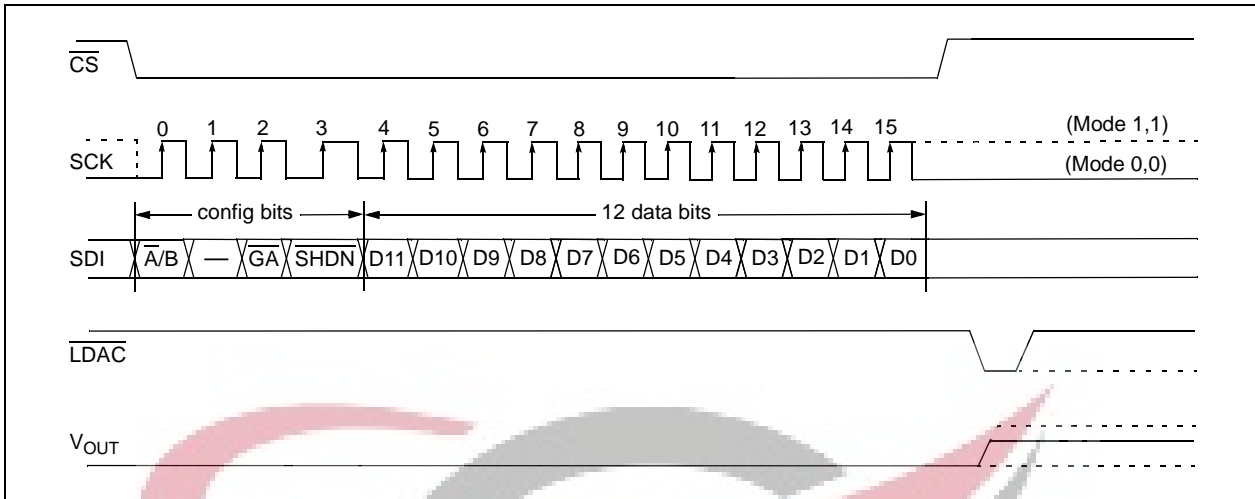

FIGURE 5-1: Write Command.

SKYTECH
ELECTRONIC

6.0 TYPICAL APPLICATIONS

The MCP482X devices are general purpose DACs intended to be used in applications where a precision, low-power DAC with moderate bandwidth and internal voltage reference is required.

Applications generally suited for the MCP482X devices include:

- Set Point or Offset Trimming
- Sensor Calibration
- Precision Selectable Voltage Reference
- Portable Instrumentation (Battery-Powered)
- Calibration of Optical Communication Devices

6.1 Digital Interface

The MCP482X devices utilize a 3-wire synchronous serial protocol to transfer the DACs' setup and output values from the digital source. The serial protocol can be interfaced to SPI™ or Microwire peripherals common on many microcontroller units (MCUs), including Microchip's PICmicro® MCUs and dsPIC® DSC family of MCUs. In addition to the three serial connections (\overline{CS} , SCK and SDI), the LDAC signal synchronizes when the serial settings are latched into the DAC's output from the serial input latch. Figure 6-1 illustrates the required connections. Note that LDAC is active-low. If desired, this input can be tied low to reduce the required connections from 4 to 3. Write commands will be latched directly into the output latch when a valid 16 clock transmission has been received and \overline{CS} has been raised.

6.2 Power Supply Considerations

The typical application will require a bypass capacitor in order to filter high-frequency noise. The noise can be induced onto the power supply's traces or as a result of changes on the DAC's output. The bypass capacitor helps to minimize the effect of these noise sources on signal integrity. Figure 6-1 illustrates an appropriate bypass strategy.

In this example, the recommended bypass capacitor value is 0.1 μF . This capacitor should be placed as close to the device power pin (V_{DD}) as possible (within 4 mm).

The power source supplying these devices should be as clean as possible. If the application circuit has separate digital and analog power supplies, AV_{DD} and AV_{SS} should reside on the analog plane.

6.3 Output Noise Considerations

The voltage noise density (in $\mu\text{V}/\sqrt{\text{Hz}}$) is illustrated in Figure 2-9. This noise appears at V_{OUTX} , and is primarily a result of the internal reference voltage. Its 1/f corner (f_{CORNER}) is approximately 400 Hz.

Figure 2-10 illustrates the voltage noise (in mV_{RMS} or $\text{mV}_{\text{P-P}}$). A small bypass capacitor on V_{OUTX} is an effective method to produce a single-pole Low-Pass Filter (LPF) that will reduce this noise. For instance, a bypass capacitor sized to produce a 1 kHz LPF would result in an E_{NREF} of about 100 μV_{RMS} . This would be necessary when trying to achieve the low DNL performance (at $G = 1$) that the MCP482X devices are capable of. The tested range for stability is .001 μF thru 4.7 μF .

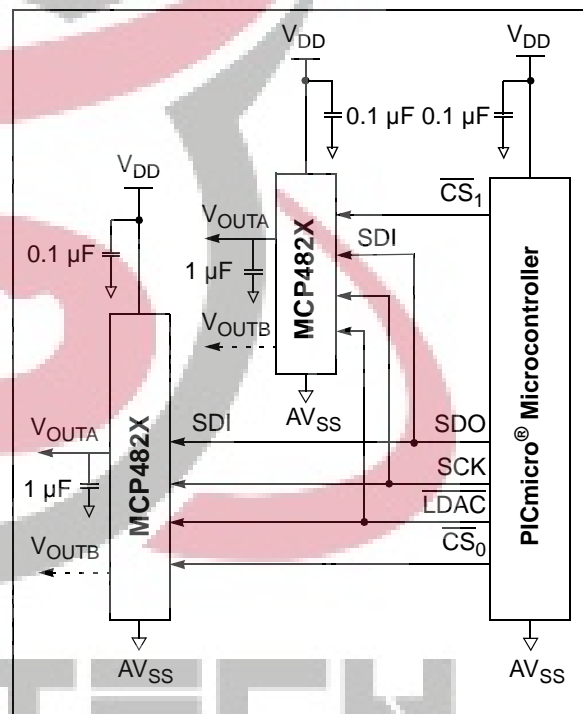

FIGURE 6-1: Typical Connection Diagram.

6.4 Layout Considerations

Inductively-coupled AC transients and digital switching noise can degrade the output signal integrity, potentially masking the MCP482X family's performance. Careful board layout will minimize these effects and increase the Signal-to-Noise Ratio (SNR). Bench testing has shown that a multi-layer board utilizing a low-inductance ground plane, isolated inputs, isolated outputs and proper decoupling are critical to achieving the performance that the MCP482X devices are capable of providing. Particularly harsh environments may require shielding of critical signals.

Breadboards and wire-wrapped boards are not recommended if low noise is desired.

MCP4821/MCP4822

6.5 Single-Supply Operation

The MCP482X devices are Rail-to-Rail (R-R) input and output DACs designed to operate with a V_{DD} range of 2.7V to 5.5V. Its output amplifier is robust enough to drive common, small-signal loads directly, thus eliminating the cost and size of an external buffer for most applications.

6.5.1 DC SET POINT OR CALIBRATION

A common application for a DAC with the MCP482X family's performance is a digitally-controlled set point and/or calibration of variable parameters, such as sensor offset or slope. 12-bit resolution provides 4096 output steps. If $G = 1$ is selected, then the internal 2.048 V_{REF} would produce 500 μV of resolution. If $G = 2$ is selected, the internal 2.048 V_{REF} would produce 1 mV of resolution.

6.5.1.1 Decreasing The Output Step Size

If the application is calibrating the threshold of a diode, transistor or resistor tied to AV_{SS} , a threshold range of 0.8V may be desired to provide 200 μV resolution. Two common methods to achieve a 0.8V range is to either reduce V_{REF} to 0.82V (would require MCP492X device and external voltage reference) or use a voltage divider on the DAC's output. Typically, when using a low-voltage V_{REF} , the noise floor causes SNR error that is intolerable. The voltage divider method provides some advantages when V_{REF} needs to be very low or when the desired output voltage is not available. Using two resistors to scale the output range down to the precise desired level is a simple, low-cost method to achieve very small step sizes. Example 6-1 illustrates this concept. Note that the bypass capacitor on the output of the voltage divider plays a critical function in attenuating the output noise of the DAC and the induced noise from the environment.

The MCP482X family's low ± 0.75 (max.) DNL performance is critical to meeting calibration accuracy in production.

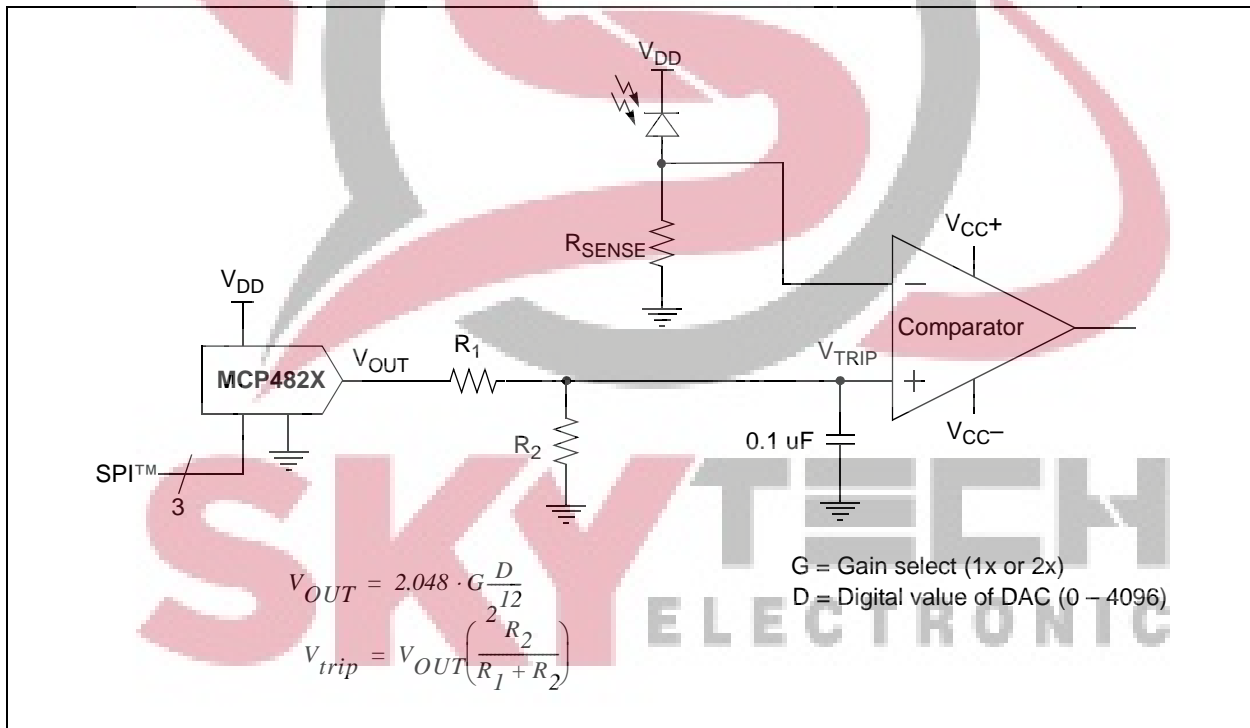

EXAMPLE 6-1: Set Point or Threshold Calibration.

6.5.1.2 Building a “Window” DAC

When calibrating a set point or threshold of a sensor, rarely does the sensor utilize the entire output range of the DAC. If the LSB size is adequate to meet the application’s accuracy needs, the resolution is sacrificed without consequences. If greater accuracy is needed, then the output range will need to be reduced to increase the resolution around the desired threshold. If the threshold is not near V_{REF} , $2V_{REF}$ or AV_{SS} , then

creating a “window” around the threshold has several advantages. One simple method to create this “window” is to use a voltage divider network with a pull-up and pull-down resistor. Example 6-2 and Example 6-4 illustrates this concept.

The MCP482X family’s low ± 0.75 (max.) DNL performance is critical to meet calibration accuracy in production.

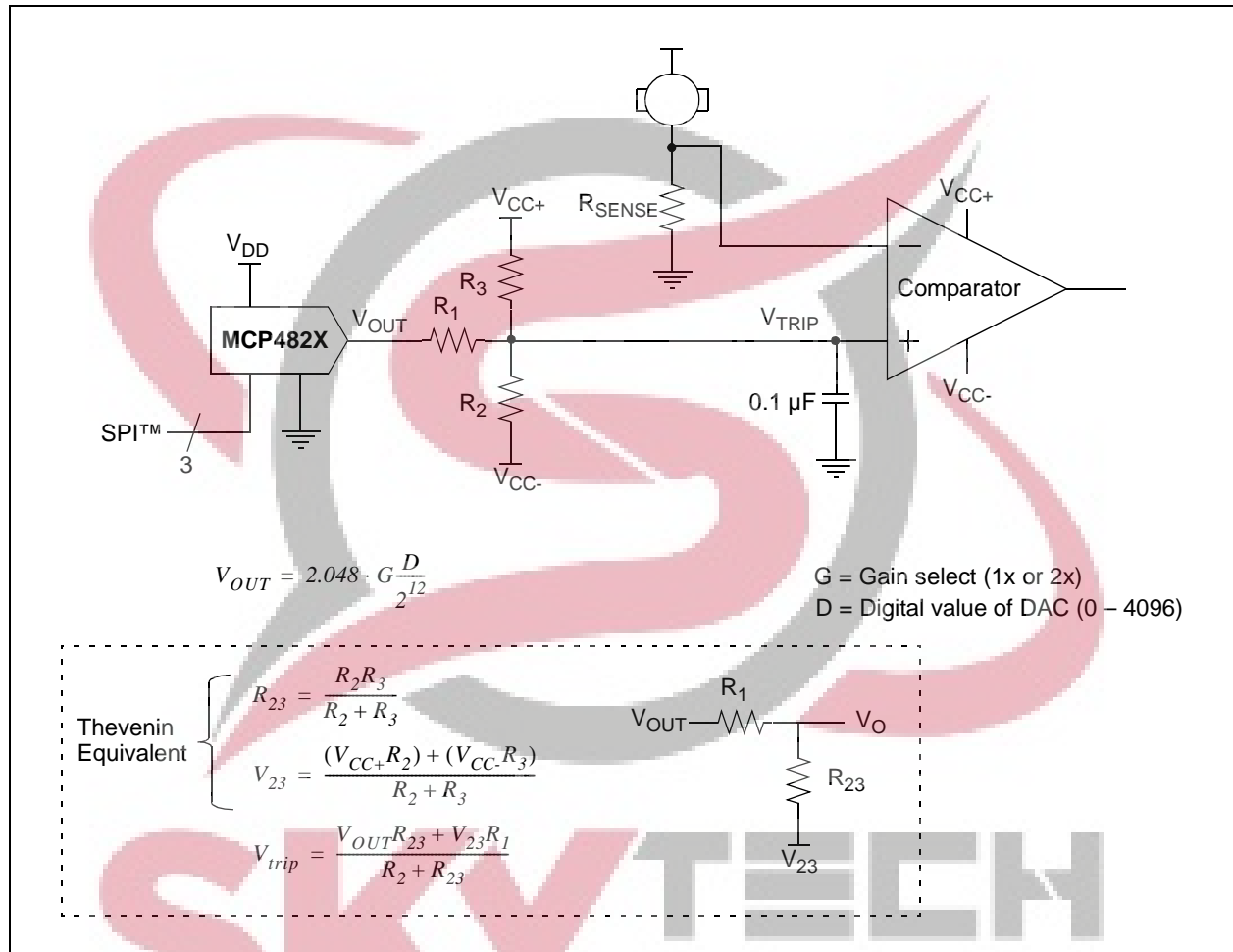

EXAMPLE 6-2: Single-Supply “Window” DAC.

MCP4821/MCP4822

6.6 Bipolar Operation

Bipolar operation is achievable using the MCP482X devices by using an external operational amplifier (op amp). This configuration is desirable due to the wide variety and availability of op amps. This allows a general purpose DAC, with its cost and availability advantages, to meet almost any desired output voltage range, power and noise performance.

Example 6-3 illustrates a simple bipolar voltage source configuration. R_1 and R_2 allow the gain to be selected, while R_3 and R_4 shift the DAC's output to a selected offset. Note that R_4 can be tied to V_{DD} , instead of AV_{SS} , if a higher offset is desired. Note that a pull-up to V_{DD} could be used, instead of R_4 or in addition to R_4 , if a higher offset is desired.

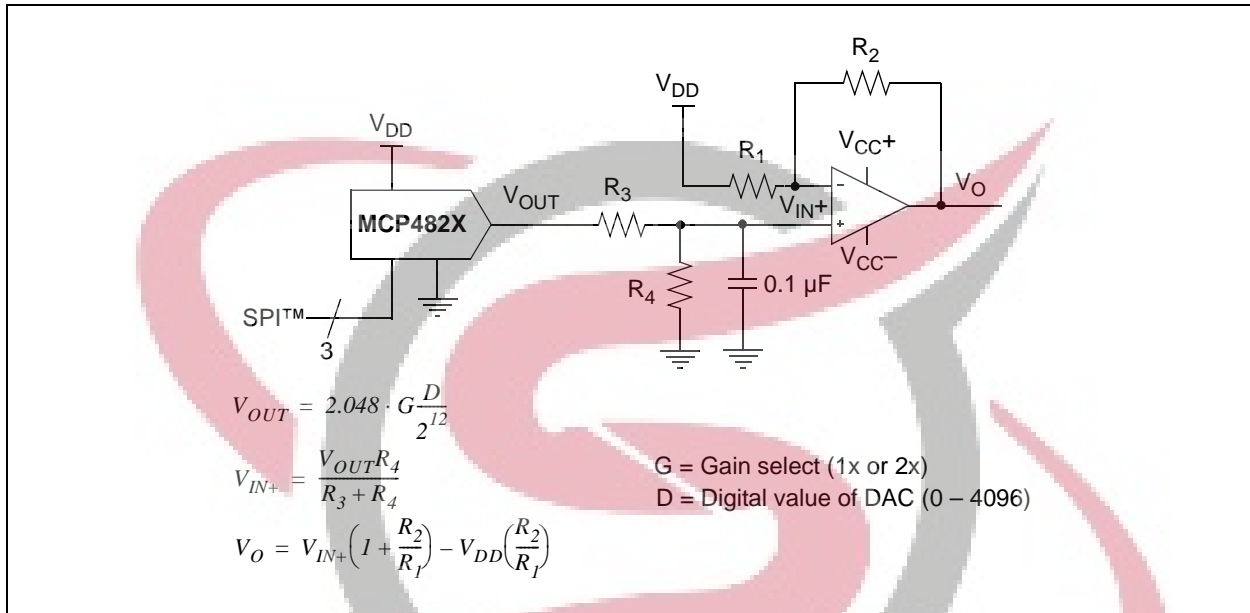

EXAMPLE 6-3: Digitally-Controlled Bipolar Voltage Source.

6.6.1 DESIGN A BIPOLAR DAC USING EXAMPLE 6-3

An output step magnitude of 1 mV, with an output range of $\pm 2.05V$, is desired for a particular application.

- Calculate the range: $+2.05V - (-2.05V) = 4.1V$.
- Calculate the resolution needed:
 $4.1V/1 \text{ mV} = 4100$
 Since $2^{12} = 4096$, 12-bit resolution is desired.
- The amplifier gain (R_2/R_1), multiplied by full-scale V_{OUT} (4.096V), must be equal to the desired minimum output to achieve bipolar operation. Since any gain can be realized by choosing resistor values (R_1+R_2), the V_{REF} value must be selected first. If a V_{REF} of 4.096V is used ($G=2$), solve for the amplifier's gain by setting the DAC to 0, knowing that the output needs to be -2.05V. The equation can be simplified to:

$$\frac{-R_2}{R_1} = \frac{-2.05}{4.096V} \quad \frac{R_2}{R_1} = \frac{1}{2}$$

If $R_1 = 20 \text{ k}\Omega$ and $R_2 = 10 \text{ k}\Omega$, the gain will be 0.5

- Next, solve for R_3 and R_4 by setting the DAC to 4096, knowing that the output needs to be +2.05V.

$$\frac{R_4}{(R_3 + R_4)} = \frac{2.05V + (0.5 \cdot 4.096V)}{1.5 \cdot 4.096V} = \frac{2}{3}$$

If $R_4 = 20 \text{ k}\Omega$, then $R_3 = 10 \text{ k}\Omega$

6.7 Selectable Gain and Offset Bipolar Voltage Output Using A Dual DAC

In some applications, precision digital control of the output range is desirable. Example 6-4 illustrates how to use the MCP482X family to achieve this in a bipolar or single-supply application.

This circuit is typically used for linearizing a sensor whose slope and offset varies.

The equation to design a bipolar “window” DAC would be utilized if R_3 , R_4 and R_5 are populated.

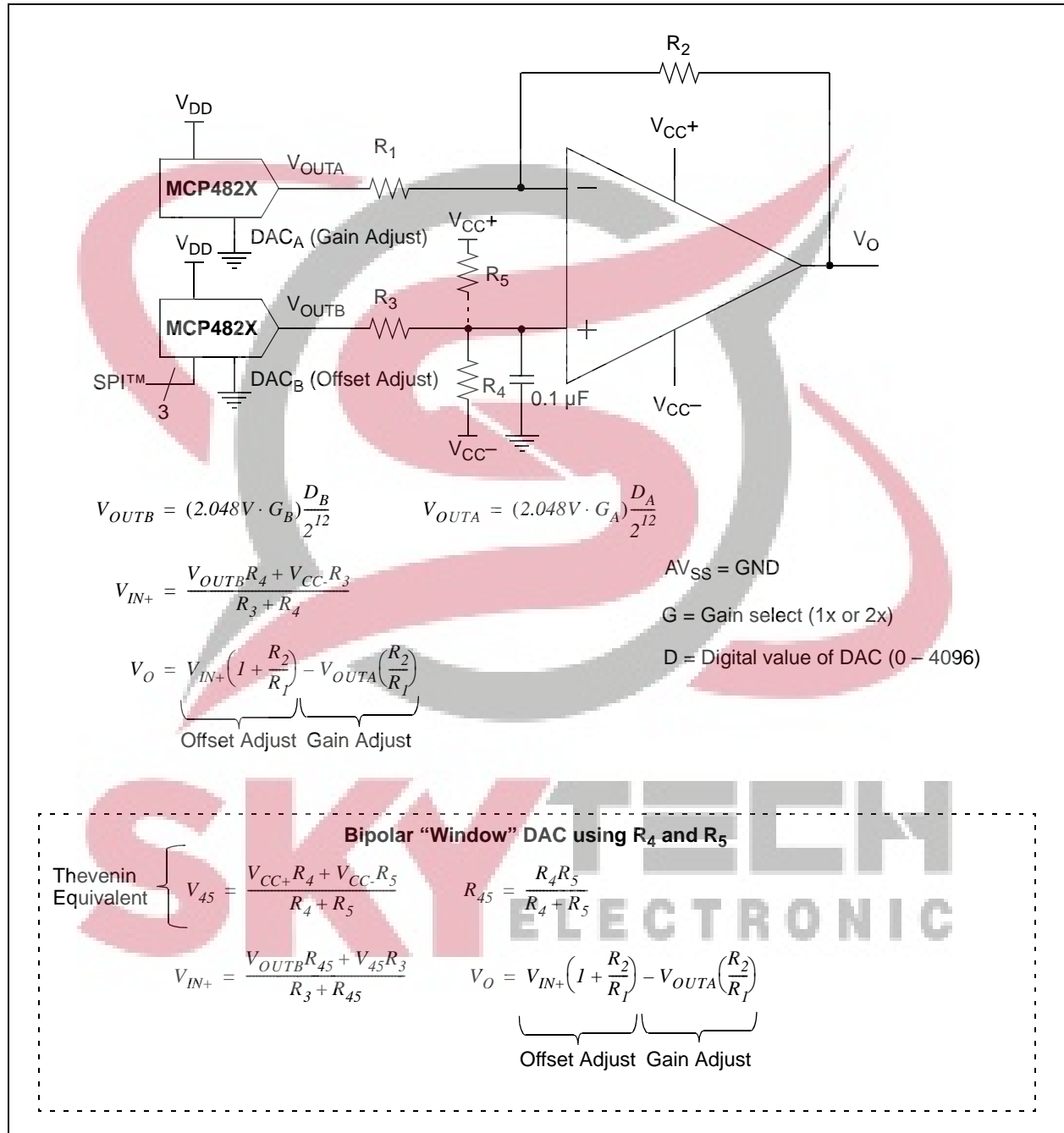

EXAMPLE 6-4: Bipolar Voltage Source with Selectable Gain and Offset.

MCP4821/MCP4822

6.8 Designing A Double-Precision DAC Using A Dual DAC

Example 6-5 illustrates how to design a single-supply voltage output capable of up to 24-bit resolution from a dual 12-bit DAC. This design is simply a voltage divider with a buffered output.

As an example, if a similar application to the one developed in Section 6.6.1 “Design a Bipolar DAC Using Example 6-3” required a resolution of 1 μV instead of 1 mV, and a range of 0V to 4.1V, then 12-bit resolution would not be adequate.

1. Calculate the resolution needed:
 $4.1V/1\ \mu V = 4.1e06$. Since $2^{22} = 4.2e06$, 22-bit resolution is desired. Since $DNL = \pm 0.75\ \text{LSb}$, this design can be attempted with the MCP482X family.
2. Since DAC_B's V_{OUTB} has a resolution of 1 mV, its output only needs to be “pulled” 1/1000 to meet the 1 μV target. Dividing V_{OUTA} by 1000 would allow the application to compensate for DAC_B's DNL error.
3. If R_2 is 100Ω, then R_1 needs to be 100 kΩ.
4. The resulting transfer function is shown in the equation of Example 6-5.

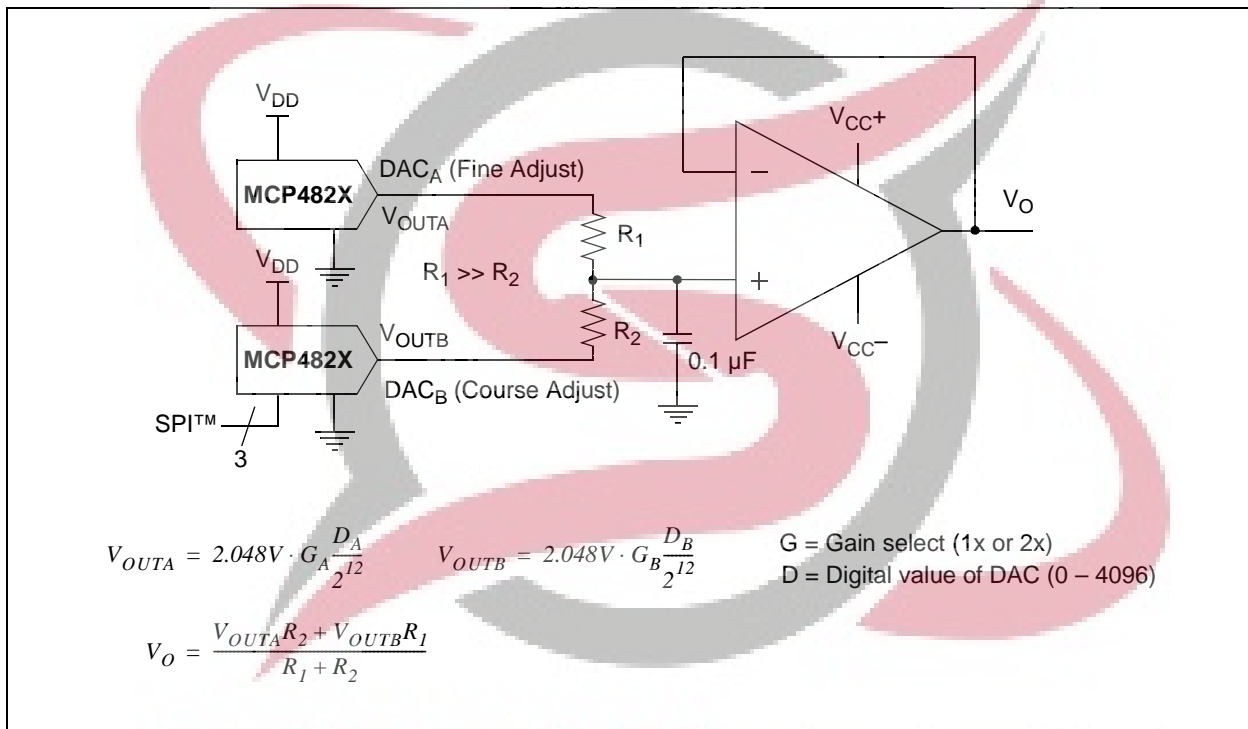

EXAMPLE 6-5: Simple, Double-Precision DAC.



6.9 Building A Programmable Current Source

Example 6-6 illustrates a variation on a voltage follower design where a sense resistor is used to convert the DAC's voltage output into a digitally-selectable current source.

Adding the resistor network from Example 6-2 would be advantageous in this application. The smaller R_{SENSE} is, the less power dissipated across it. However, this also reduces the resolution that the current can be controlled with. The voltage divider, or "window", DAC configuration would allow the range to be reduced, thus increasing resolution around the range of interest. When working with very small sensor voltages, plan on eliminating the amplifier's offset error by storing the DAC's setting under known sensor conditions.

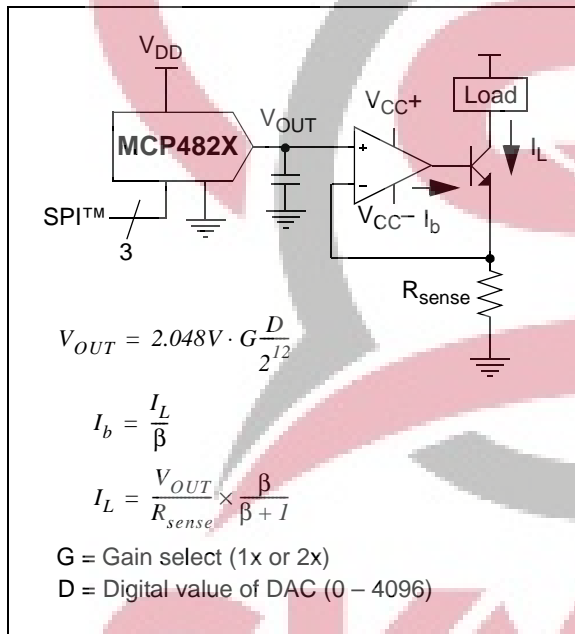

EXAMPLE 6-6: Digitally-Controlled Current Source.

MCP4821/MCP4822

7.0 DEVELOPMENT SUPPORT

7.1 Evaluation & Demonstration Boards

The Mixed Signal PICtail™ Demo Board supports the MCP482X family of devices. Refer to www.microchip.com for further information on this product's capabilities and availability.

7.2 Application Notes

Application notes illustrating the performance and implementation of the MCP482X family are planned but are currently not released. Refer to www.microchip.com for further information.



8.0 PACKAGING INFORMATION

8.1 Package Marking Information

8-Lead MSOP

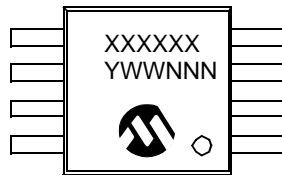

Example:

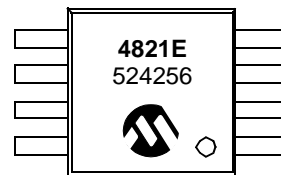

8-Lead PDIP (300 mil)

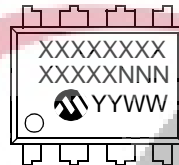

Example:

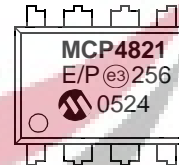

8-Lead SOIC (150 mil)



Example:



Legend:	XX...X	Customer-specific information
	Y	Year code (last digit of calendar year)
	YY	Year code (last 2 digits of calendar year)
	WW	Week code (week of January 1 is week '01')
	NNN	Alphanumeric traceability code
	(e3)	Pb-free JEDEC designator for Matte Tin (Sn)
	*	This package is Pb-free. The Pb-free JEDEC designator (e3) can be found on the outer packaging for this package.

Note: In the event the full Microchip part number cannot be marked on one line, it will be carried over to the next line, thus limiting the number of available characters for customer-specific information.

MCP4821/MCP4822

8-Lead Plastic Micro Small Outline Package (MS) (MSOP)

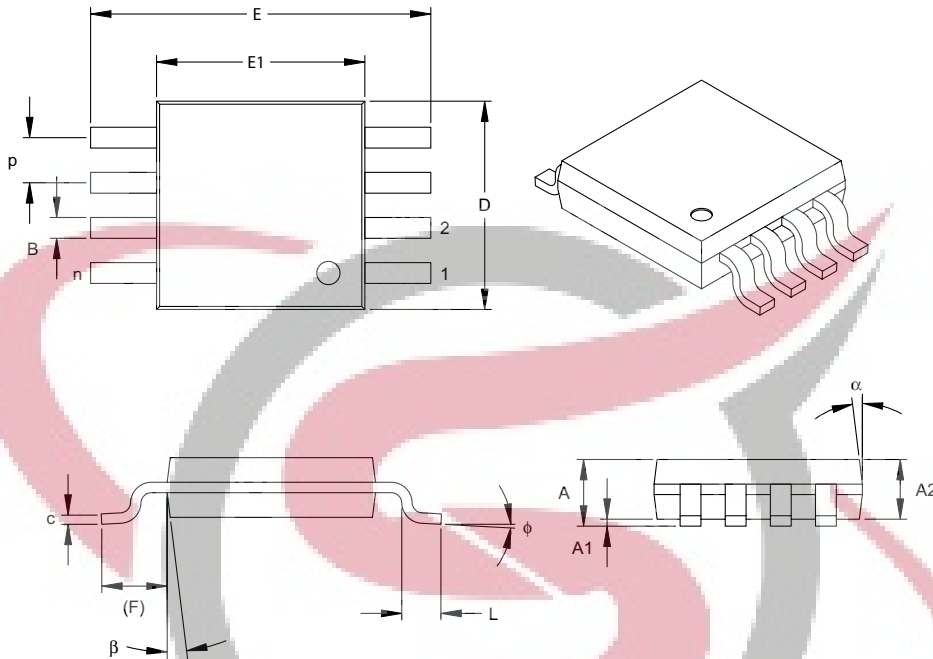

Dimension Limits	Units	INCHES			MILLIMETERS*		
		MIN	NOM	MAX	MIN	NOM	MAX
Number of Pins	n		8			8	
Pitch	p	.026 BSC			0.65 BSC		
Overall Height	A	-	-	.043	-	-	1.10
Molded Package Thickness	A2	.030	.033	.037	0.75	0.85	0.95
Standoff	A1	.000	-	.006	0.00	-	0.15
Overall Width	E	.193 TYP.			4.90 BSC		
Molded Package Width	E1	.118 BSC			3.00 BSC		
Overall Length	D	.118 BSC			3.00 BSC		
Foot Length	L	.016	.024	.031	0.40	0.60	0.80
Footprint (Reference)	F	.037 REF			0.95 REF		
Foot Angle	phi	0°	-	8°	0°	-	8°
Lead Thickness	c	.003	.006	.009	0.08	-	0.23
Lead Width	B	.009	.012	.016	0.22	-	0.40
Mold Draft Angle Top	alpha	5°	-	15°	5°	-	15°
Mold Draft Angle Bottom	beta	5°	-	15°	5°	-	15°

*Controlling Parameter

Notes:

Dimensions D and E1 do not include mold flash or protrusions. Mold flash or protrusions shall not exceed .010" (0.254mm) per side.

JEDEC Equivalent: MO-187

Drawing No. C04-111

MCP4821/MCP4822

8-Lead Plastic Dual In-line (P) – 300 mil (PDIP)

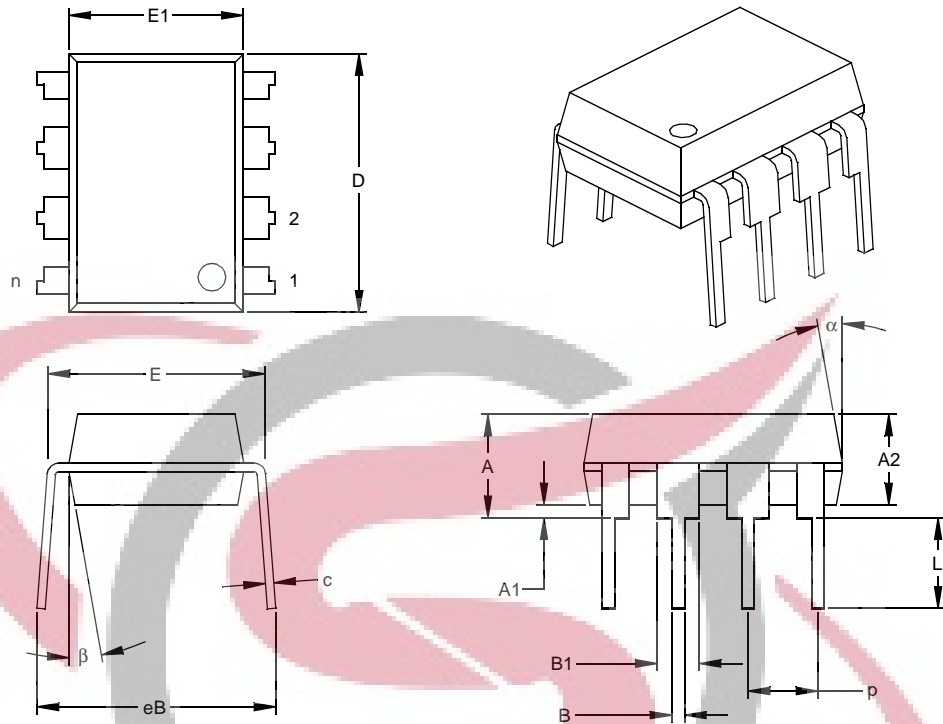

Dimension Limits	Units	INCHES*			MILLIMETERS		
		MIN	NOM	MAX	MIN	NOM	MAX
Number of Pins	n		8			8	
Pitch	p		.100			2.54	
Top to Seating Plane	A	.140	.155	.170	3.56	3.94	4.32
Molded Package Thickness	A2	.115	.130	.145	2.92	3.30	3.68
Base to Seating Plane	A1	.015			0.38		
Shoulder to Shoulder Width	E	.300	.313	.325	7.62	7.94	8.26
Molded Package Width	E1	.240	.250	.260	6.10	6.35	6.60
Overall Length	D	.360	.373	.385	9.14	9.46	9.78
Tip to Seating Plane	L	.125	.130	.135	3.18	3.30	3.43
Lead Thickness	c	.008	.012	.015	0.20	0.29	0.38
Upper Lead Width	B1	.045	.058	.070	1.14	1.46	1.78
Lower Lead Width	B	.014	.018	.022	0.36	0.46	0.56
Overall Row Spacing	§ eB	.310	.370	.430	7.87	9.40	10.92
Mold Draft Angle Top	α	5	10	15	5	10	15
Mold Draft Angle Bottom	β	5	10	15	5	10	15

* Controlling Parameter
 § Significant Characteristic

Notes:
 Dimensions D and E1 do not include mold flash or protrusions. Mold flash or protrusions shall not exceed .010" (0.254mm) per side.
 JEDEC Equivalent: MS-001
 Drawing No. C04-018

MCP4821/MCP4822

8-Lead Plastic Small Outline (SN) – Narrow, 150 mil (SOIC)

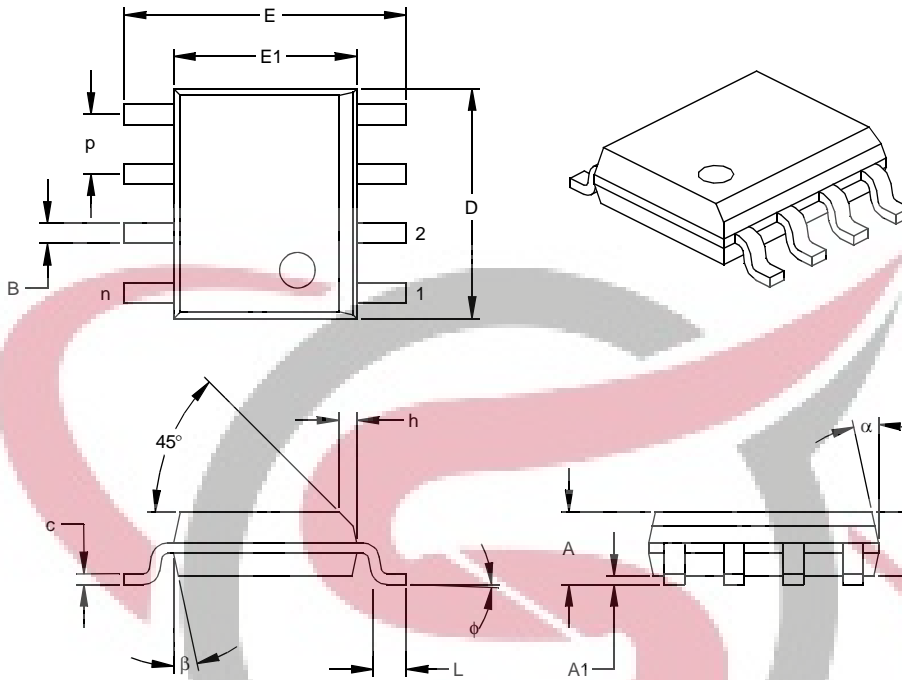

Dimension	Units	INCHES*			MILLIMETERS		
		MIN	NOM	MAX	MIN	NOM	MAX
Number of Pins	n		8			8	
Pitch	p		.050			1.27	
Overall Height	A	.053	.061	.069	1.35	1.55	1.75
Molded Package Thickness	A2	.052	.056	.061	1.32	1.42	1.55
Standoff §	A1	.004	.007	.010	0.10	0.18	0.25
Overall Width	E	.228	.237	.244	5.79	6.02	6.20
Molded Package Width	E1	.146	.154	.157	3.71	3.91	3.99
Overall Length	D	.189	.193	.197	4.80	4.90	5.00
Chamfer Distance	h	.010	.015	.020	0.25	0.38	0.51
Foot Length	L	.019	.025	.030	0.48	0.62	0.76
Foot Angle	φ	0	4	8	0	4	8
Lead Thickness	c	.008	.009	.010	0.20	0.23	0.25
Lead Width	B	.013	.017	.020	0.33	0.42	0.51
Mold Draft Angle Top	α	0	12	15	0	12	15
Mold Draft Angle Bottom	β	0	12	15	0	12	15

* Controlling Parameter

§ Significant Characteristic

Notes:

Dimensions D and E1 do not include mold flash or protrusions. Mold flash or protrusions shall not exceed .010" (0.254mm) per side.

JEDEC Equivalent: MS-012

Drawing No. C04-057

APPENDIX A: REVISION HISTORY

Revision A (June 2005)

- Original Release of this Document.



NOTES:



PRODUCT IDENTIFICATION SYSTEM

To order or obtain information, e.g., on pricing or delivery, refer to the factory or the listed sales office.

<u>PART NO.</u>	<u>X</u>	<u>/XX</u>	Examples:
Device	Temperature Range	Package	
Device:	MCP4821:	12-Bit DAC with SPI™ Interface	a) MCP4821T-E/SN: Tape and Reel
	MCP4821T:	12-Bit DAC with SPI Interface (Tape and Reel) (SOIC, MSOP)	Extended Temperature, 8LD SOIC package.
	MCP4822:	12-Bit DAC with SPI Interface	b) MCP4821T-E/MS: Tape and Reel
	MCP4822T:	12-Bit DAC with SPI Interface (Tape and Reel) (SOIC, MSOP)	Extended Temperature, 8LD MSOP package.
Temperature Range:	E	= -40°C to +125°C	c) MCP4821-E/SN: Extended Temperature, 8LD SOIC package.
Package:	MS	= Plastic MSOP, 8-lead	d) MCP4821-E/MS: Extended Temperature, 8LD MSOP package.
	P	= Plastic DIP (300 mil Body), 8-lead	e) MCP4821-E/P: Extended Temperature, 8LD PDIP package.
	SN	= Plastic SOIC, (150 mil Body), 8-lead	a) MCP4822T-E/SN: Tape and Reel
			Extended Temperature, 8LD SOIC package.
			b) MCP4822-E/P: Extended Temperature, 8LD PDIP package.
			c) MCP4822-E/SN: Extended Temperature, 8LD SOIC package.



SKYTECH
ELECTRONIC

NOTES:



Note the following details of the code protection feature on Microchip devices:

- Microchip products meet the specification contained in their particular Microchip Data Sheet.
- Microchip believes that its family of products is one of the most secure families of its kind on the market today, when used in the intended manner and under normal conditions.
- There are dishonest and possibly illegal methods used to breach the code protection feature. All of these methods, to our knowledge, require using the Microchip products in a manner outside the operating specifications contained in Microchip's Data Sheets. Most likely, the person doing so is engaged in theft of intellectual property.
- Microchip is willing to work with the customer who is concerned about the integrity of their code.
- Neither Microchip nor any other semiconductor manufacturer can guarantee the security of their code. Code protection does not mean that we are guaranteeing the product as "unbreakable."

Code protection is constantly evolving. We at Microchip are committed to continuously improving the code protection features of our products. Attempts to break Microchip's code protection feature may be a violation of the Digital Millennium Copyright Act. If such acts allow unauthorized access to your software or other copyrighted work, you may have a right to sue for relief under that Act.

Information contained in this publication regarding device applications and the like is provided only for your convenience and may be superseded by updates. It is your responsibility to ensure that your application meets with your specifications. MICROCHIP MAKES NO REPRESENTATIONS OR WARRANTIES OF ANY KIND WHETHER EXPRESS OR IMPLIED, WRITTEN OR ORAL, STATUTORY OR OTHERWISE, RELATED TO THE INFORMATION, INCLUDING BUT NOT LIMITED TO ITS CONDITION, QUALITY, PERFORMANCE, MERCHANTABILITY OR FITNESS FOR PURPOSE. Microchip disclaims all liability arising from this information and its use. Use of Microchip's products as critical components in life support systems is not authorized except with express written approval by Microchip. No licenses are conveyed, implicitly or otherwise, under any Microchip intellectual property rights.

Trademarks

The Microchip name and logo, the Microchip logo, Accuron, dsPIC, KEELoq, microID, MPLAB, PIC, PICmicro, PICSTART, PRO MATE, PowerSmart, rfPIC, and SmartShunt are registered trademarks of Microchip Technology Incorporated in the U.S.A. and other countries.

AmpLab, FilterLab, Migratable Memory, MXDEV, MXLAB, PICMASTER, SEEVAL, SmartSensor and The Embedded Control Solutions Company are registered trademarks of Microchip Technology Incorporated in the U.S.A.

Analog-for-the-Digital Age, Application Maestro, dsPICDEM, dsPICDEM.net, dsPICworks, ECAN, ECONOMONITOR, FanSense, FlexROM, fuzzyLAB, In-Circuit Serial Programming, ICSP, ICEPIC, Linear Active Thermistor, MPASM, MPLIB, MPLINK, MPSIM, PICkit, PICDEM, PICDEM.net, PICLAB, PICtail, PowerCal, PowerInfo, PowerMate, PowerTool, rFLAB, rfPICDEM, Select Mode, Smart Serial, SmartTel, Total Endurance and WiperLock are trademarks of Microchip Technology Incorporated in the U.S.A. and other countries.

SQTP is a service mark of Microchip Technology Incorporated in the U.S.A.

All other trademarks mentioned herein are property of their respective companies.

© 2005, Microchip Technology Incorporated, Printed in the U.S.A., All Rights Reserved.

 Printed on recycled paper.

**QUALITY MANAGEMENT SYSTEM
CERTIFIED BY DNV
== ISO/TS 16949:2002 ==**

Microchip received ISO/TS-16949:2002 quality system certification for its worldwide headquarters, design and wafer fabrication facilities in Chandler and Tempe, Arizona and Mountain View, California in October 2003. The Company's quality system processes and procedures are for its PICmicro® 8-bit MCUs, KEELoq® code hopping devices, Serial EEPROMs, microperipherals, nonvolatile memory and analog products. In addition, Microchip's quality system for the design and manufacture of development systems is ISO 9001:2000 certified.



MICROCHIP

WORLDWIDE SALES AND SERVICE

AMERICAS

Corporate Office
2355 West Chandler Blvd.
Chandler, AZ 85224-6199
Tel: 480-792-7200
Fax: 480-792-7277
Technical Support:
<http://support.microchip.com>
Web Address:
www.microchip.com

Atlanta
Alpharetta, GA
Tel: 770-640-0034
Fax: 770-640-0307

Boston
Westborough, MA
Tel: 774-760-0087
Fax: 774-760-0088

Chicago
Itasca, IL
Tel: 630-285-0071
Fax: 630-285-0075

Dallas
Addison, TX
Tel: 972-818-7423
Fax: 972-818-2924

Detroit
Farmington Hills, MI
Tel: 248-538-2250
Fax: 248-538-2260

Kokomo
Kokomo, IN
Tel: 765-864-8360
Fax: 765-864-8387

Los Angeles
Mission Viejo, CA
Tel: 949-462-9523
Fax: 949-462-9608

San Jose
Mountain View, CA
Tel: 650-215-1444
Fax: 650-961-0286

Toronto
Mississauga, Ontario,
Canada
Tel: 905-673-0699
Fax: 905-673-6509

ASIA/PACIFIC

Australia - Sydney
Tel: 61-2-9868-6733
Fax: 61-2-9868-6755

China - Beijing
Tel: 86-10-8528-2100
Fax: 86-10-8528-2104

China - Chengdu
Tel: 86-28-8676-6200
Fax: 86-28-8676-6599

China - Fuzhou
Tel: 86-591-8750-3506
Fax: 86-591-8750-3521

China - Hong Kong SAR
Tel: 852-2401-1200
Fax: 852-2401-3431

China - Shanghai
Tel: 86-21-5407-5533
Fax: 86-21-5407-5066

China - Shenyang
Tel: 86-24-2334-2829
Fax: 86-24-2334-2393

China - Shenzhen
Tel: 86-755-8203-2660
Fax: 86-755-8203-1760

China - Shunde
Tel: 86-757-2839-5507
Fax: 86-757-2839-5571

China - Qingdao
Tel: 86-532-502-7355
Fax: 86-532-502-7205

ASIA/PACIFIC

India - Bangalore
Tel: 91-80-2229-0061
Fax: 91-80-2229-0062

India - New Delhi
Tel: 91-11-5160-8631
Fax: 91-11-5160-8632

Japan - Kanagawa
Tel: 81-45-471-6166
Fax: 81-45-471-6122

Korea - Seoul
Tel: 82-2-554-7200
Fax: 82-2-558-5932 or
82-2-558-5934

Malaysia - Penang
Tel: 011-604-646-8870
Fax: 011-604-646-5086

Philippines - Manila
Tel: 011-632-634-9065
Fax: 011-632-634-9069

Singapore
Tel: 65-6334-8870
Fax: 65-6334-8850

Taiwan - Kaohsiung
Tel: 886-7-536-4818
Fax: 886-7-536-4803

Taiwan - Taipei
Tel: 886-2-2500-6610
Fax: 886-2-2508-0102

Taiwan - Hsinchu
Tel: 886-3-572-9526
Fax: 886-3-572-6459

EUROPE

Austria - Weis
Tel: 43-7242-2244-399
Fax: 43-7242-2244-393

Denmark - Ballerup
Tel: 45-4450-2828
Fax: 45-4485-2829

France - Massy
Tel: 33-1-69-53-63-20
Fax: 33-1-69-30-90-79

Germany - Ismaning
Tel: 49-89-627-144-0
Fax: 49-89-627-144-44

Italy - Milan
Tel: 39-0331-742611
Fax: 39-0331-466781

Netherlands - Drunen
Tel: 31-416-690399
Fax: 31-416-690340

England - Berkshire
Tel: 44-118-921-5869
Fax: 44-118-921-5820



Mouser Electronics

Authorized Distributor

Click to View Pricing, Inventory, Delivery & Lifecycle Information:

[Microchip:](#)

[MCP4822-E/MS](#) [MCP4822-E/P](#) [MCP4822-E/SN](#) [MCP4822T-E/MS](#) [MCP4822T-E/SN](#)

